

Accessories Help You . . .

Set a Filter Service Schedule:

- Restriction indicators — go-no-go, lock-up styles, electric, in-field manometers, safety filter indicator.

Aspirate (or scavenge) an intake system:

- Strata™ Cap
- Large Vane Pre-Cleaner
- Donaspin™
- Exhaust Ejectors
- Air Stack Extension
- Check Valve

Evacuate air cleaner dust:

- Vacuator™ Valves
- Quick Release Dust Cups
- Dust Dumpa
- Donaspin™
- STB Air System

Solve air intake water problems:

- Air Ram™ Inlet Hood
- In-line Moisture Skimmer
- In-line Moisture Separator

Pre-clean or protect air inlet from debris:

- Pre-cleaners
 - Strata™ Cap
 - TopSpin™ Pre-Cleaner
 - TopSpin™ HD Pre-Cleaner
 - Large Vane Pre-Cleaner
 - Full-View Pre-Cleaner
 - In-line Separator
 - Donaspin™
- Air Ram™ Inlet Hood
- Inlet Hoods

Connect intake components:

- Rubber Elbows and Connectors
- Clamps
 - Aluminum Tubing
 - Rubber and Silicone Hump/Reducers
 - Charge Air Connectors

Mount or install an air cleaner:

- Mounting Bands
- Straight Pipe



Section Index

Pre-Cleaners	190
Strata™ Cap	192
TopSpin™	196
TopSpin™ HD	198
Large Vane	200
Full-View	202
Donaspin™	204
In-Line Separators	205
Inlet Hoods / Rain Caps	206
Air Cleaner Mounting Bands	208
Hose & T-Bolt Clamps	209
Filter Service Indicators, Switches and Sensors	210
Rubber Elbows & Connectors	220
Charge Air Connectors	223
Vacuator™ Valves	224
Dust Dumpa Tube Extensions	226
Exhaust Ejectors	228
Ejector Check Valves	229
Inlet Hood, Air Ram™	230
Moisture Skimmer	231
Air Stack Extensions	232
Intake Tubing	232
Breathers	232

No Matter What Dust Condition, Pre-cleaners Extend Air Filter Life

Pre-cleaners remove contaminant of varying sizes from entering the intake duct, and they don't require any engine power to operate. Some devices collect the contaminant (Full-View), others just eject or drop the contaminant (TopSpin™, TopSpin™ HD, in-line separator), or are connected via a scavenge system and route debris out the exhaust system (Donaspin, Strata™ Cap).

Product Offering

- Six pre-cleaner styles offer the broadest product range in the industry
- Strata™ Cap is the new scavenge system option for operating in heavy dust environments
- TopSpin™ HD is the new all-metal option for heavy-duty applications where a rugged and durable pre-cleaner is needed
- Pre-cleaners extend life of vehicle air filters and serve as rain caps
- Units are made of durable materials — either metal or impact resistant plastic
- Most units install outside of engine compartment — leaving more space under hood for other components (exception-in-line separator)
- No wires or power requirements
- Please note: Strata Cap and Donaspin require additional components for scavenge system — hoses, check valves, clamps and exhaust ejector

To Scavenge or Not To Scavenge . . .

Air cleaners are designed to operate with or without aspiration. Aspiration (otherwise known as scavenging) is accomplished by introducing a secondary airflow in the intake ducting (generally through the use of an exhaust ejector or ejector muffler). This secondary airflow pulls the separated contaminant from the pre-cleaner and ejects it into the exhaust stream.



The advantages to scavenging are:

- Higher pre-cleaner efficiency (resulting in longer primary filter service life)
- Completely self-servicing (no regular maintenance needed on pre-cleaner)
- Drop tube can be located in a variety of orientations (not just straight down as is necessary on non-scavenged systems)

Aspirating an intake system through the use of a scavenging device adds more components (an ejector and some plumbing) to the overall system, but will enhance the separator efficiency of the pre-cleaner and consequently extend the primary filter service life.

An alternative . . . Air Cleaners with Built-in Pre-Cleaning

Before you decide on adding a pre-cleaner. Take a look at our PowerCore® air cleaner housings — the PowerCore PSD Series. PowerCore air cleaners have a pre-cleaning section built directly into the housing. If you have the room, choosing a PowerCore air cleaner will reduce the number of components in your intake system — fewer parts to track, maintain and manage. And, some PSD air cleaner models can also be used in scavenged systems.

See the PowerCore PSD Series section, beginning on page 30, for more information.

Selection

Select the style that matches dust conditions, airflow and desired efficiency level. Each pre-cleaner family is presented on the following pages.

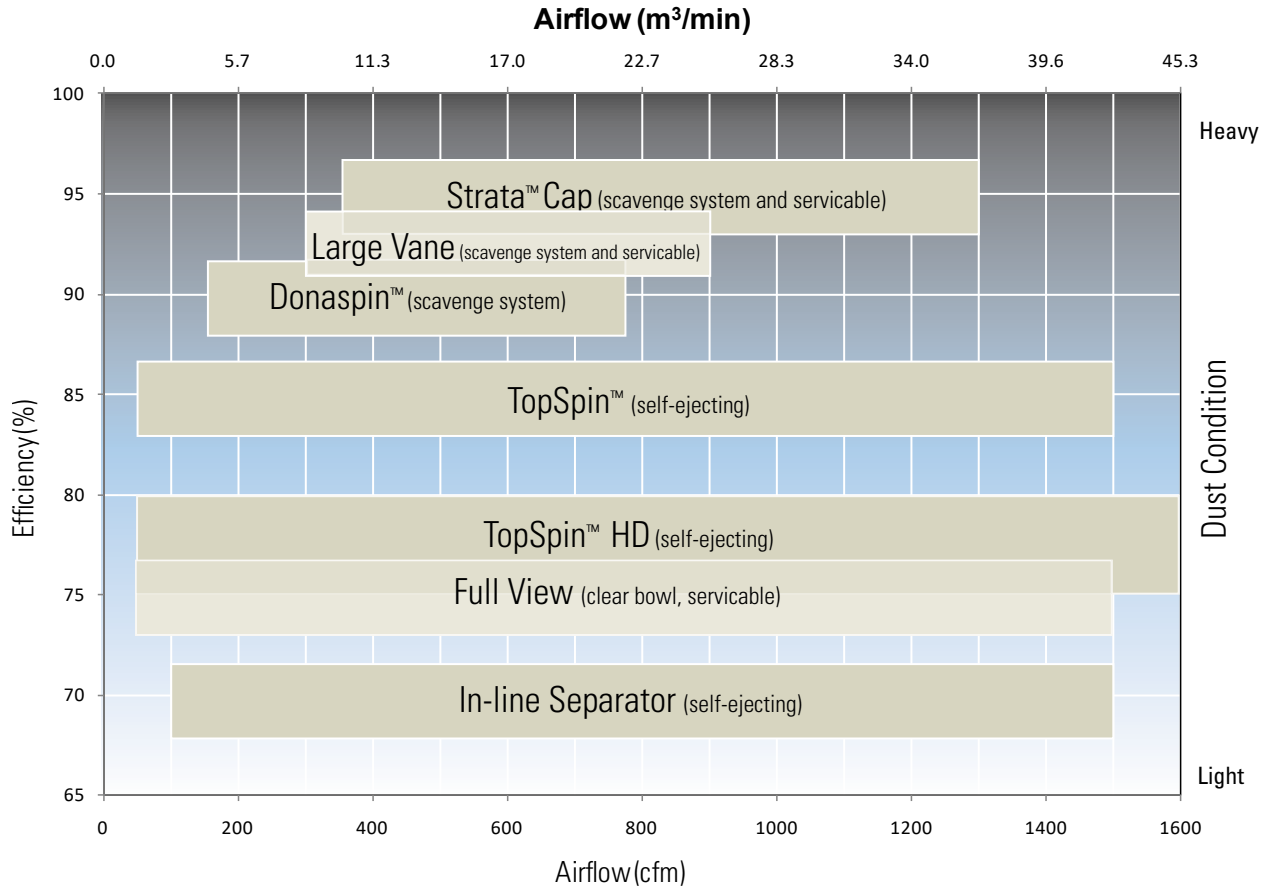

Compare – Weight, Scavenge, Service and Materials

Additional characteristics about our pre-cleaner line to help you decide on the style that’s best for you.

Dust Condition	Max. Sepr Efficiency	Unit Weight Range lbs.	Unit Weight Range kg.	Pre-Cleaner Family	Scavenge Required	Service Required	Material
Heavy	96%	6.2 – 9.1	2.82 – 4.14	Strata™ Cap	Yes	Yes	Plastic
	94%	2.5	1.13	Large Vane	Yes	No	Plastic
	90%	8.0 – 10.0	3.63 – 4.54	Donaspin™	Yes	No	Steel
Medium	85%	1.0 – 6.0	0.45 – 2.72	TopSpin™	No	No	Plastic
	80%	1.0 – 9.5	0.5 – 4.3	TopSpin™ HD	No	No	Aluminum/ Stainless Steel
Light	70%	11.5 – 14.8	5.23 – 6.70	In-Line Separator	No	No	Steel
	75%	0.8 – 9.2	0.37 – 4.17	Full-View	No	Yes	Steel/Plastic

Low Profile Pre-cleaner and Rain Cap in One!

The scavenged Strata™ Cap pre-cleaner removes up to 96% of incoming contaminant — the highest efficiency compared to all other Donaldson pre-cleaners. It is designed for the most demanding heavy dust environments in the construction and mining industry.

Features

Separates up to 96% of incoming contaminant per ISO 5011/SAE J726

- Significantly extends air filter life
- Reduces air filter servicing and replacement
- Lowers cost per operating hour
- Separates more than 99% of 20 micron and above particles

Low profile for maximum operator visibility

Robust design for heavy-duty environments

- No moving parts
- Both a rain cap and pre-cleaner
- No bowl to clean or empty
- UV resistant plastic construction

Simple installation

- Unit installs outside of engine compartment, leaving more space under hood for other components
- No wires or power requirements
- Requires additional standard components for scavenge

Lighter Weight

- Low profile
- Lighter weight compared to other Donaldson scavenge systems; e.g., STB System and Donaspin™ pre-cleaner

Application

- Accommodates a range of airflows from 350 to 1,300 cfm (9.9-36.8 m³/min).
- Primarily used in heavy dust environments
- Great for off-road vehicles and equipment from crawler tractors to farm tractors to skid steer loaders
- Recommended mounting: outside of engine compartment on top of the air cleaner inlet stack



The scavenged Strata™ Cap pre-cleaner removes up to 96% of incoming contaminant — the highest pre-cleaning efficiency ever invented by Donaldson.



Advantages of Scavenging

Scavenging is accomplished by introducing a secondary airflow to the drop tube on the air cleaner (generally through the use of an ejector or ejector muffler). This flow pulls the separated contaminant from the pre-cleaner and inserts it into the exhaust stream.

- Higher pre-cleaner efficiency (resulting in longer filter service life)
- Completely self-servicing (no regular maintenance needed on pre-cleaner)

Aspirating an intake system through the use of a scavenging device adds more components (an ejector and some plumbing) to the overall system, but will enhance the separator efficiency of the pre-cleaner and consequently extend the filter service life.

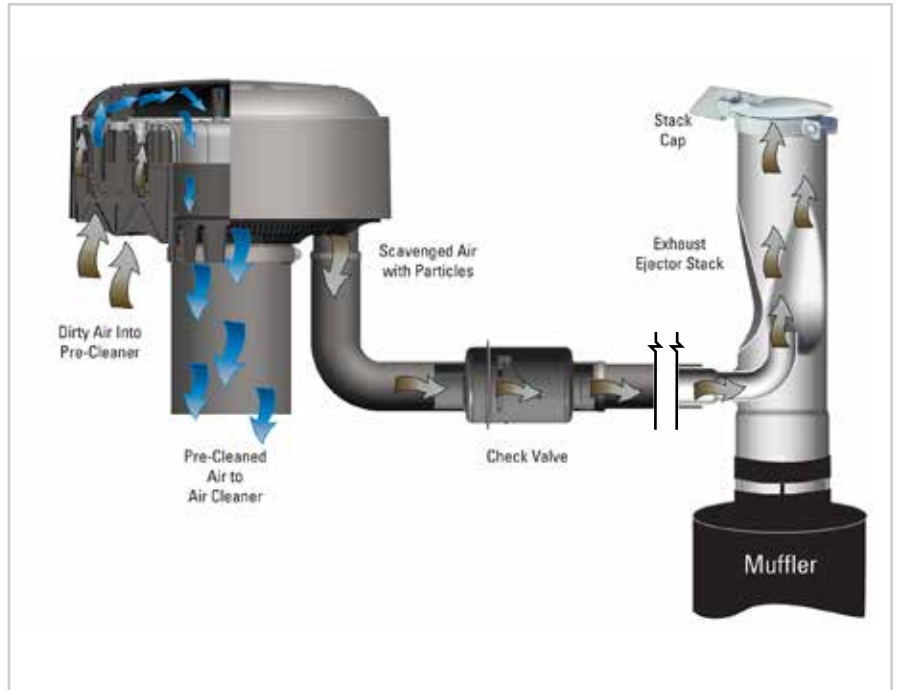

Performance — Restriction at 10% Scavenge

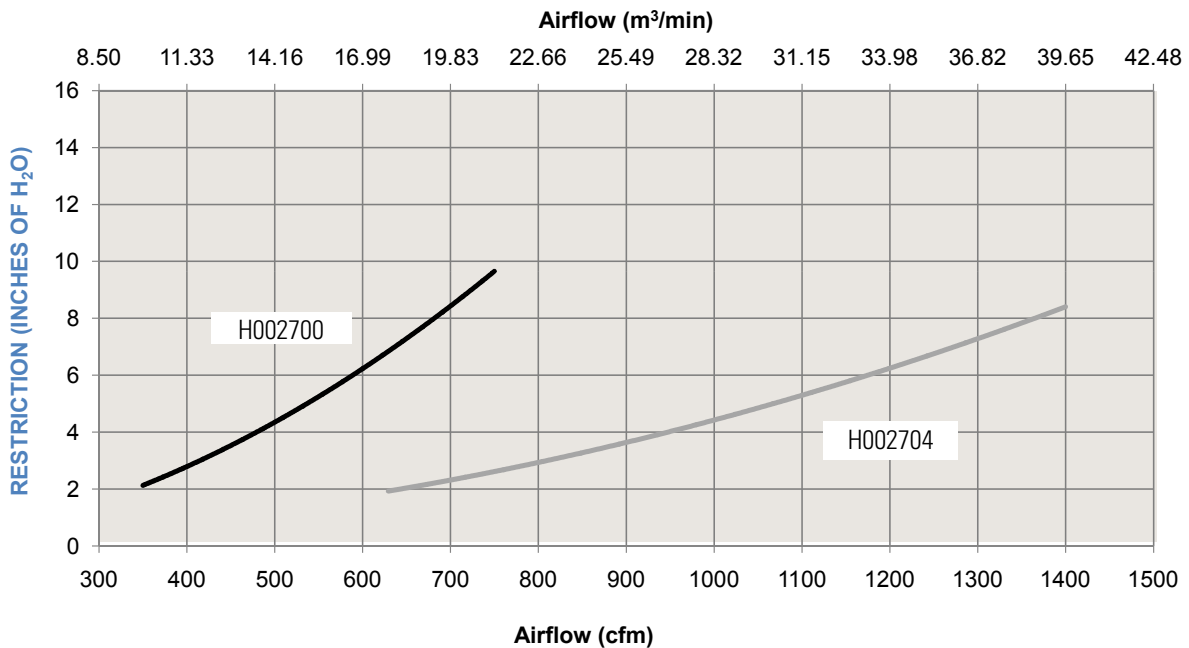

Performance – Initial Efficiency at 10% Scavenge

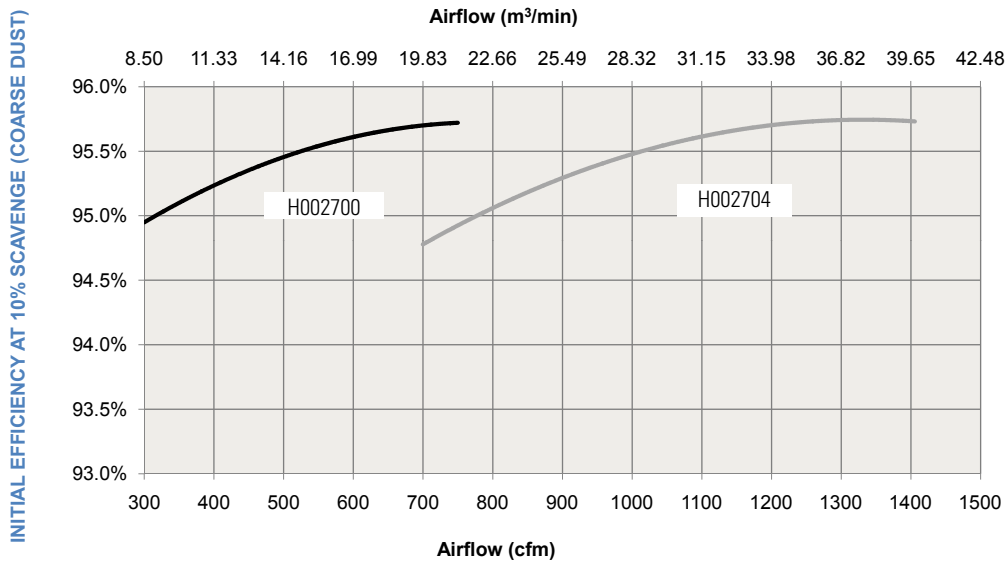

Dimensional Specifications



Part Number	Overall Height (A)		Body Dia. (B)		Outlet I.D. (C)		Scavenge Hose I.D. (D)		Weight		Rated Air Flow @ 6" H ₂ O
	in	mm	in	mm	in	mm	in	mm	lbs.	kg.	
H002700	8.00	218	14.00	356	5.00	127	2.00	51	6.2	2.8	600 cfm / 17.0 m³/m
H002704	8.60	218	17.20	437	8.00	203	2.00	51	8.8	4.0	1140 cfm / 32.3 m³/m

Installation

For proper function, the pre-cleaner/rain cap installs over a 5.0" or 8.0" OD metal intake tube and connects to a 2.0" I.D. scavenge hose. The scavenge hose should be secured from movement within 12.0" / 305mm of the pre-cleaner/rain cap.

Additional components are required for proper installation:

- Scavenge hose (2.0" / 51mm I.D.) need enough for two cut lengths connecting to the Strata™ Cap to check valve and the check valve to exhaust ejector
- Hose clamps (x 4) (Part No. P115200)
- Check Valve (Part No. H000722)
- Metal Intake Tube (O.D.) to mount Strata™ Cap to Air Cleaner (5.0" / 127mm or 8.0" / 203mm Dia. — depends on your Strata™ Cap size)
- Standard and expanded I.D. exhaust ejectors available



Service Procedure

The pre-cleaner/rain cap may need to be cleaned over time. The procedure below recommends removal and disassembly of the unit to clean. The unit can be cleaned with either water, mild-soapy water or compressed air. Tapping or hitting the components to dislodge contaminant should be avoided. It may cause damage and prevent reassembly.

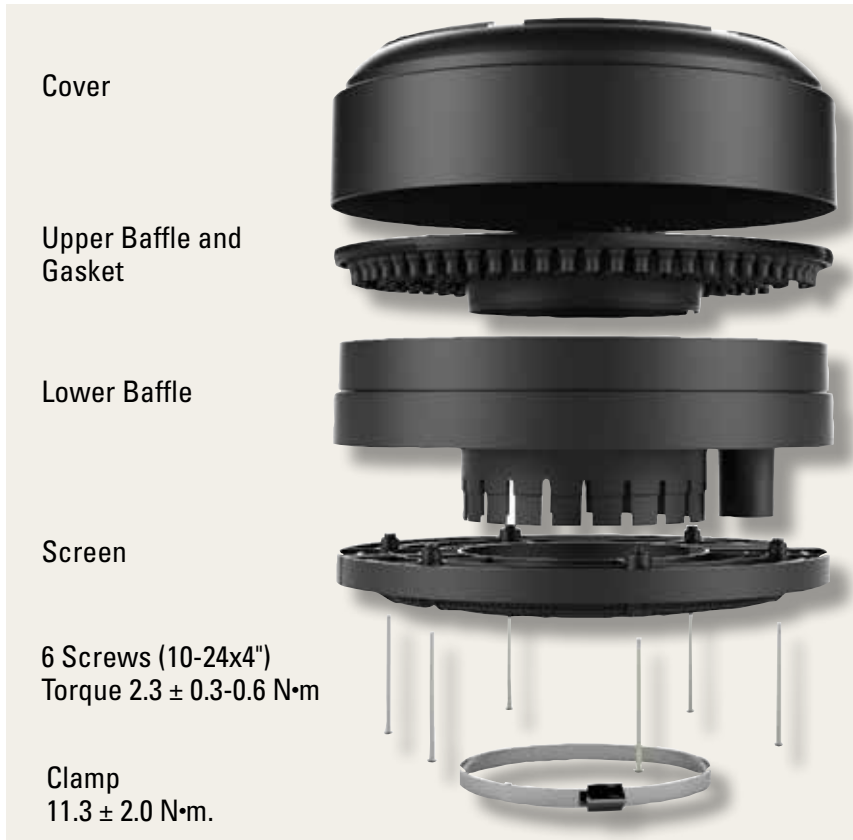

Cover

Upper Baffle and Gasket

Lower Baffle

Screen

6 Screws (10-24x4")
Torque 2.3 ± 0.3-0.6 N•m

Clamp
11.3 ± 2.0 N•m.

1. Turn off engine.
2. Loosen both connecting clamps (metal pipe and scavenge hose) and remove the Strata™ Cap pre-cleaner.
3. Turn unit upside down. Remove the screws (save for reassembly) and disassemble the unit (screen is two pieces).

Note: Cover or plug intake pipe to protect air intake system from contamination during service.

4. Clean all the parts to remove dust and debris from each component.
5. After cleaning, inspect the gasket on the perimeter of the upper baffle. If damaged in any way replace with new gasket. Check gasket position, make sure it is installed evenly around upper baffle perimeter.

Note: Using the unit without gasket properly installed will affect Strata™ Cap pre-cleaning performance.

Service Parts

Strata™ Cap Model No.

H002700
H002704

Gasket

P617476
P167475

1/2 Screen

P617922
P617923

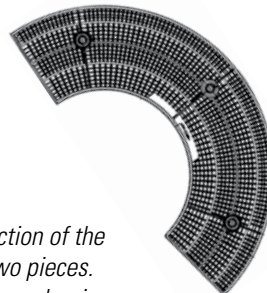

Entire screen section of the Strata™ Cap is two pieces. The service part number is one screen only.

6. With cover upside down, reassemble components. Unit has alignment guides to aide reassembly.
7. With all components together, reinstall and torque the 6 screws to 2.3 ± 0.3-0.6 N•m

Note: Removable screw adhesive is to be used on the screws if original blue patch has been worn off.

8. Replace Strata™ Cap on intake stack, reconnect scavenge hose. Tighten clamps to torque specifications. If scavenge support was disconnected, reconnect.

TopSpin™ Can Extend Filter Life in Heavy Dust Conditions

Donaldson TopSpin™ will extend primary air filter life, boost system efficiency, and extend engine life.

Features

Separates up to 85% of incoming contaminant per ISO 5011/SAE J726

- Greatly extends air filter life
- Reduces air filter usage
- Lowers cost per operating hour
- Automatically ejects mixed debris
- Separates more than 99% of 20 micron and above particles

Self-cleaning/self-scavenging

- No maintenance to clean bowl
- No exhaust ejector required

Easy installation

- Quick installation
- One clamp to tighten
- No wires or power requirements

Dual mounted bearings

- More robust design
- Extends bearing life

Lighter Weight

- Lighter than competitive pre-cleaners
- Lighter than Donaldson full-view pre-cleaner

Application

- Engine airflows of 80 to 1500 cfm (2.3-42.5 m³/min).
- Primarily used in medium to heavy dust environments
- Great for off-road vehicles and equipment from crawler tractors to farm tractors to skid steer loaders
- Recommended mounting: on top of the air cleaner inlet stack



Donaldson TopSpin™ in Action
Upper left, TopSpin on excavator; **upper right**, military ground vehicle in middle east; **left**, TopSpin on pumper truck in Australia.

How it Works:

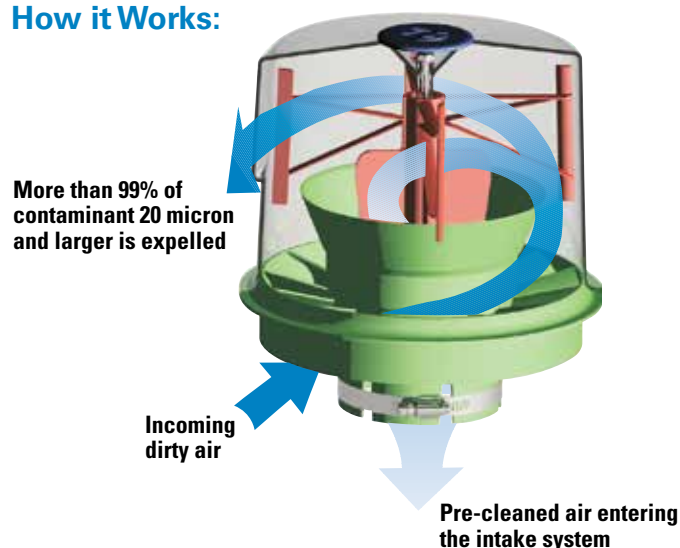

Performance Curves

Multiple tests conducted per ISO 5011/SAE J726 and average results are shown in charts below.

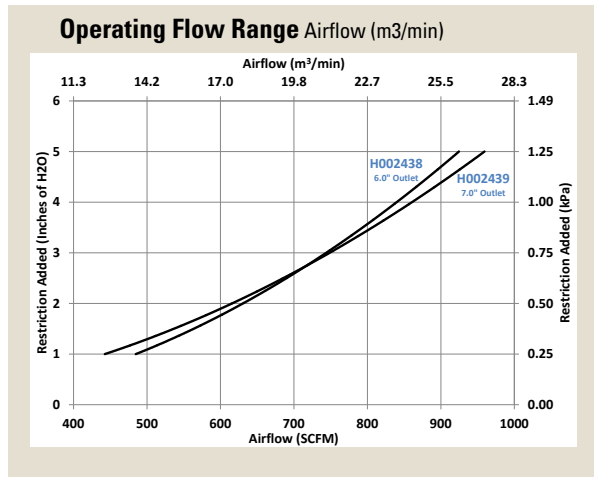
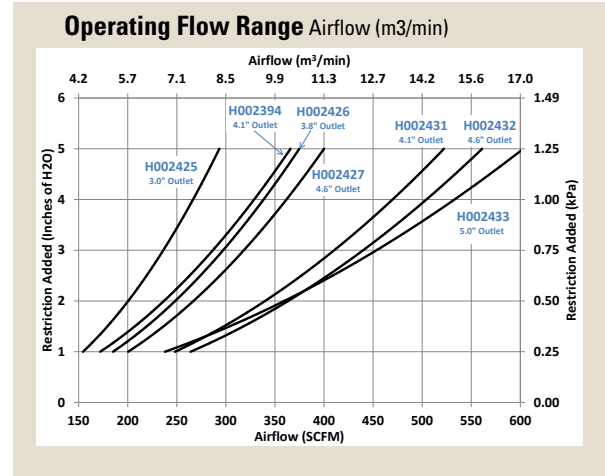
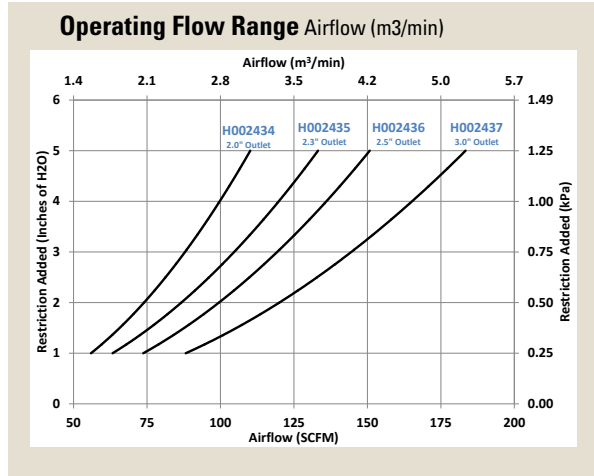

Dimensional Specifications

Donaldson TopSpin™ can be mounted horizontally or vertically. Installation instructions, stainless clamp and warranty are included. Operating temperature range: -40 °F to 180 °F (-40 °C to 82 °C)

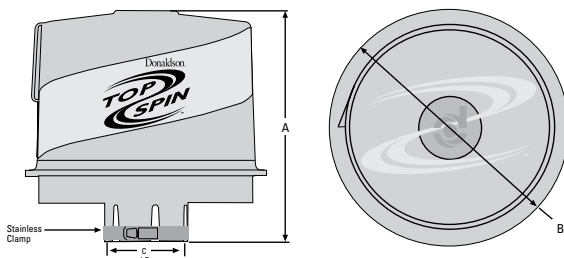

Part Number	Overall Height (A)		Body Dia. (B)		Outlet I.D. (C)		Weight	
	in	mm	in	mm	in	mm	lbs.	kg.
H002434	5.75	146	6.38	162	2.03	52	1.0	0.4
H002435	5.75	146	6.38	162	2.27	58	1.0	0.4
H002436	5.75	146	6.38	162	2.53	64	1.0	0.4
H002437	5.75	146	6.38	162	3.03	77	1.0	0.4
H002425	9.39	238	9.51	242	3.07	78	2.2	1.0
H002426	9.39	238	9.51	242	3.83	97	2.2	1.0
H002394	9.39	238	9.51	242	4.06	103	2.2	1.0
H002431	11.30	287	11.32	288	4.06	103	2.7	1.2
H002427	9.39	238	9.51	242	4.57	116	2.2	1.0
H002432	11.30	287	11.32	288	4.57	116	2.7	1.2
H002433	11.30	287	11.32	288	5.03	128	2.7	1.2
H002438	13.57	345	15.62	397	6.03	153	6.0	2.7
H002439	13.57	345	15.62	397	7.03	179	6.0	2.7

All-Metal Pre-cleaner is Durable Solution for Punishing Conditions

Donaldson TopSpin™ HD will extend primary air filter life, boost system efficiency and extend engine life in medium to heavy dust environments.

Features

Separates up to 80% of incoming contaminant per ISO 5011

- All-metal construction
- Greatly extends air filter life
- Reduces air filter usage
- Lowers cost per operating hour
- Automatically ejects mixed debris

Self-cleaning/self-scavenging

- No maintenance to clean bowl
- No exhaust ejector required

Easy installation

- Quick installation
- One clamp to tighten
- No wires or power requirements

Application

- Engine airflows of 50 to 1600 cfm (1.4-45.3 m³/min).
- Primarily used in medium to heavy dust environments
- Great for off-road vehicles and equipment, including crawler tractors, farm tractors, skid steer loaders, mining, and fracking machines
- Recommended mounting: on top of the **metal** air cleaner inlet stack. Do not mount on non-metal inlet stack



Built as tough as your equipment

Rugged one-piece **aluminum hood** with recessed discharge louver sheds flying debris.

One-piece **stainless steel impeller** is the only moving part. Dual bearings ensure reliable performance.



Stainless steel clamp with locking nut makes installation quick and secure. Clamp is included with each TopSpin HD.

All the interior components are solid stainless steel to resist dirt, water, heat, and debris encountered in demanding environments.



TopSpin HD Performance Curves

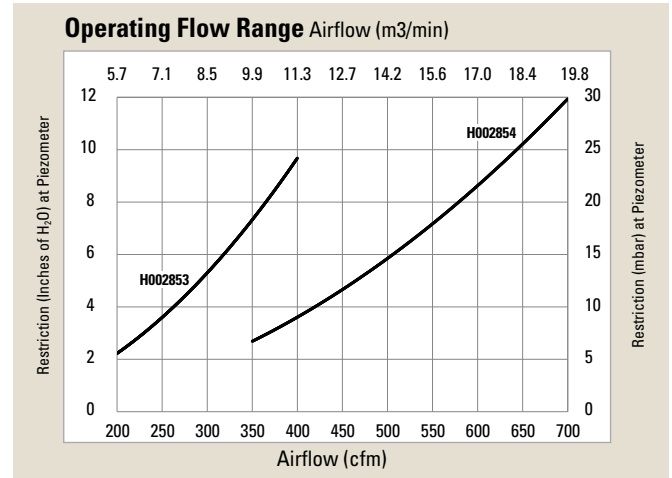
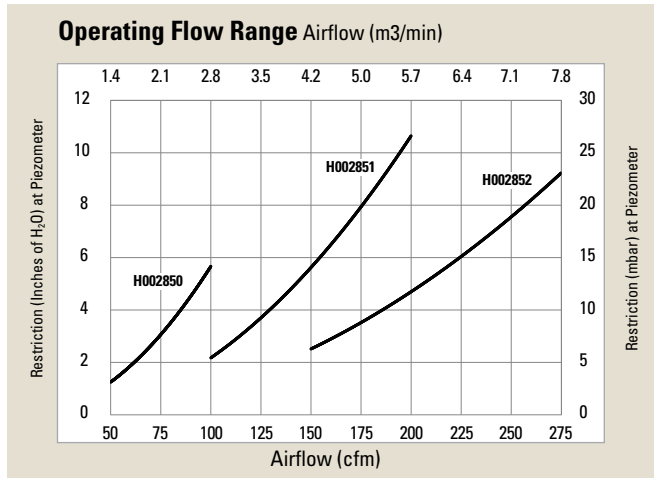

Dimensional Specifications

Donaldson TopSpin™ HD can be mounted in an upright position or horizontally with louver opening at the bottom. Installation instructions, stainless steel clamp and limited lifetime warranty are included. Operating temperature range: -40 °F to 180 °F (-40 °C to 82 °C).

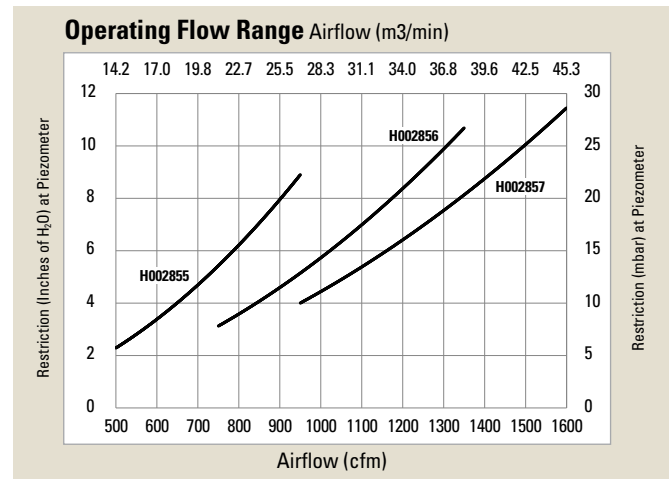
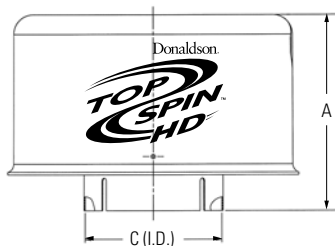
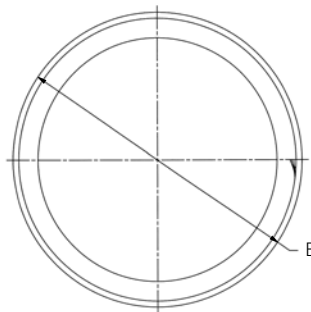

Part Number	Overall Height (A)		Body Dia. (B)		Outlet I.D. (C)		Operating Flow Range		Weight	
	in	mm	in	mm	in	mm	SCFM*	m ³ /min.	lbs.	kg.
H002850	3.41	86.5	5.4	137.2	2.06	52.3	50-100	1.4-2.8	1.0	0.5
H002851	4.25	108	6.3	160	2.58	65.5	100-200	2.8-5.6	1.75	0.8
H002852	4.96	125.9	7.2	182.9	3.07	78	150-275	4.2-7.8	2.75	1.2
H002853	5.81	147.6	8.72	221.6	4.10	104.1	200-400	5.6-11.3	3.75	1.7
H002854	7.56	192.1	11.19	284.2	5.08	129	350-700	10-20	6.5	3.0
H002855	7.72	196	12.78	324.6	6.10	154.9	500-950	14-27	7.25	3.3
H002856	8.38	212.7	14.75	374.6	7.10	180.3	750-1350	21-38	9.5	4.3
H002857	8.38	212.7	14.75	374.6	8.08	205.2	950-1600	26.6-44.8	9.5	4.3

Cross reference from a Full-View pre-cleaner to a TopSpin™ HD pre-cleaner can be found on the Full-view Pre-cleaner page.

*SCFM = Standard Cubic Feet per Minute. The ISO 5011/SAE J726 test procedure was used to extract the results in the charts above. The ISO 5011/SAE J726 is a widely accepted industry test used by OEMs to evaluate the efficiency of the intake system components. Test results are an average from testing several units.

Extends Filter Life in Large Fibrous Contaminant and Heavy Dust Conditions

The large vane pre-cleaner is specifically designed to handle large fibrous contaminant and heavy dust in agricultural and forestry applications.

The large single-vane design easily separates chaff, cotton linters, wood fibers, and other large contaminant, in addition to removing extremely heavy dust. Pre-cleaners with smaller vanes typically struggle with these types of contaminants.

Application

- Harvesters and other agricultural equipment, refuse, logging and forestry
- For engine airflows from 300–900 cfm
- Recommended mounting: external, using bracket

Features

Separates up to 94% of incoming fibrous debris from the air intake system

- Built-in large vane spins air to separate up to 94% of incoming fibrous debris and up to 90% of incoming heavy dust from the air intake system
- Works as part of a scavenged flow system to continuously expel pre-cleaned contaminants through the scavenge source
- Durable, non-corroding reinforced plastic
- High efficiency with low restriction
- No maintenance. Self-cleaning. No moving parts.



Designed to help you get the job done on time!

Rugged injection-molded body for light weight design and modular-mounting options

Removable inlet vane and captive fasteners improve serviceability

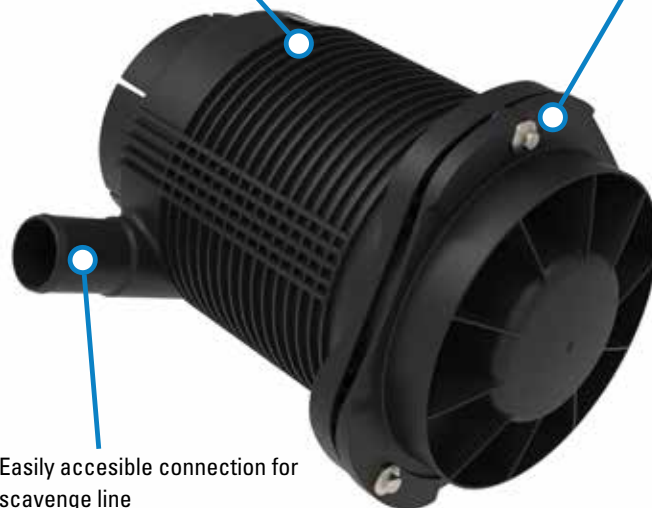

Easily accessible connection for scavenge line

Large Vane Performance Curves

Multiple tests conducted per ISO 5011/SAE J726 and average results are shown in charts below

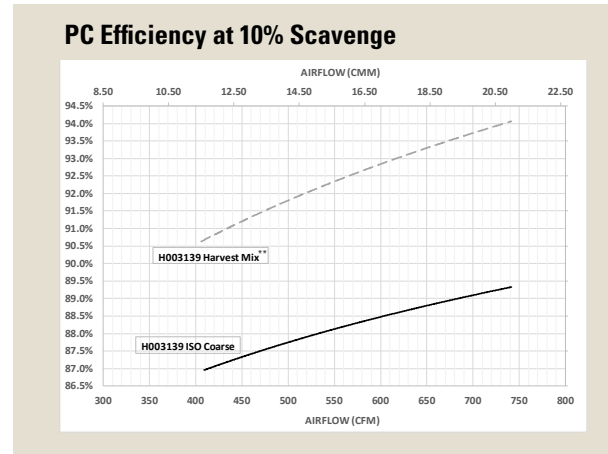
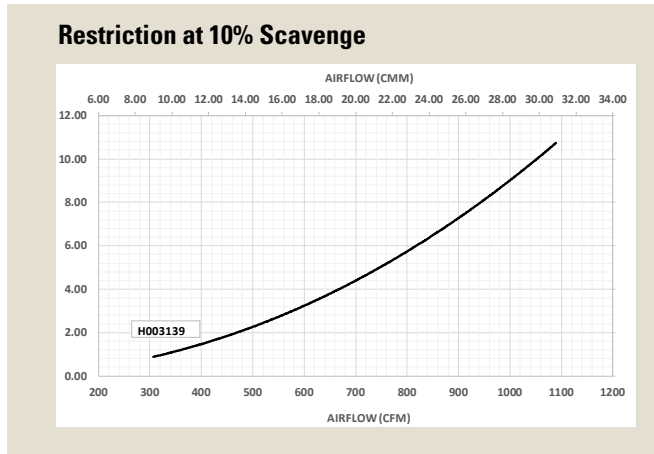

*SCFM = Standard Cubic Feet per Minute. The ISO 5011/SAE J726 test procedure was used to extract the results in the charts above. The ISO 5011/SAE J726 is a widely accepted industry test used by OEMs to evaluate the efficiency of the intake system components. Test results are an average from testing several units.

**Harvest Mix is a proprietary blend of large fibrous contaminant intended to best represent a worst-case scenario for agricultural, forestry, or similar type environment.

Dimensional Specifications

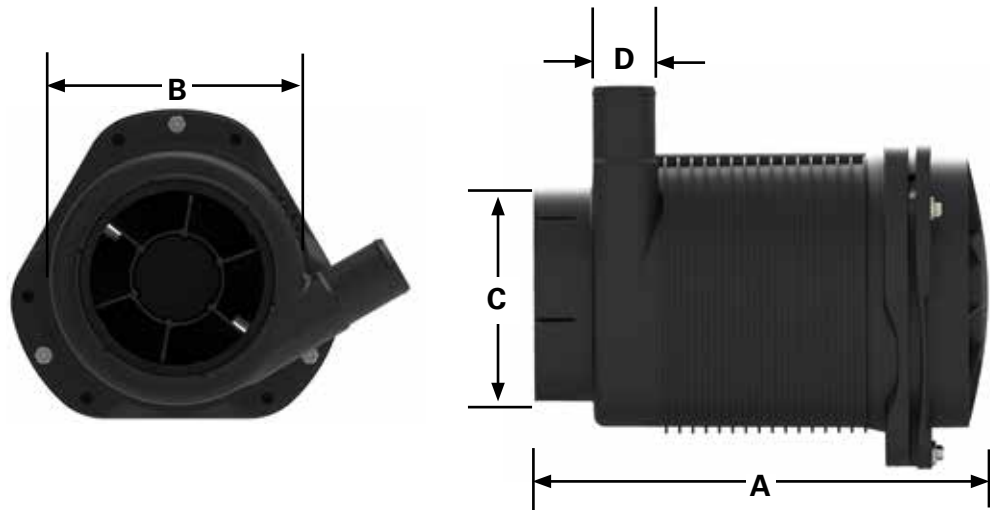

Part Number	Overall Height (A)		Body Dia. (B)		Outlet I.D. (C)		Scavenge Hose O.D. (D)		Weight		Operating Air Flow SCFM*/m³/min
	in	mm	in	mm	in	mm	in	mm	lbs.	kg.	
H003139	13.46	341.9	7.97	202.5	6.09	154.8	2.00	51	2.5	1.13	300-900 cfm / 8.5 - 25.5 m³/m

Large Vane Mounting Bands (Order one band per Large Vane pre-cleaner)

Part Number	A		B		C		D		E		Weight	
	in	mm	in	mm	in	mm	in	mm	in	mm	lbs	kgm
POLYMER BAND												
P777732 ¹	8.35	212	4.70	120	7.48	190	1.99	51	n/a	0.56	253	
METAL BAND												
H002023	8.35	212	4.72	120	4.33	110	1.99	51	5.14	131	1.60	726

WARNING: Do not use any other mounting bands or straps with Large Vane pre-cleaners. Use of an unapproved mounting band voids warranty.

Full-View Pre-Cleaner Helps Extend Filter Life on Agricultural & Construction Equipment

Features

- Recommended mounting: on top of the engine intake stack
- Centrifugal force in bowl separates up to 75% of incoming dust **before** it enters the engine air intake system
- Low maintenance
- Durable, lightweight, noncorrosive construction
- Full-view plastic bowl lets operator easily see when service is needed
- One-bolt cover retention for easy service. When dirt reaches the level of the arrow, remove top nut and plastic body, then empty — no tools required
- Mounting clamp included



Tired of Emptying the Cup?

Before you consider replacing your full-view pre-cleaner with another one, check out the TopSpin™ and TopSpin™ HD models on the previous pages.



Pre-cleaner Upgrade Path

Full-View	TopSpin	TopSpin™ HD
H000820.....	H002425	
H000821.....	H002426	
H000858.....	H002394.....	H002853
H000823.....	H002427	
H001250.....	H002435	
H001251.....	H002436.....	H002851
H001249.....	H002437.....	H002852
H001823.....	H002434.....	H002850
H002043.....	H002433.....	H002854
H002044.....	H002432	
H002045.....	H002431	
H002223.....	H002438.....	H002855
H002224.....	H002439.....	H002856
N/A	N/A	H002857

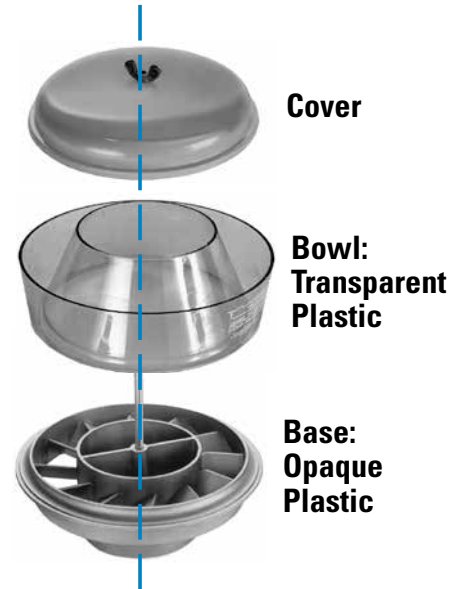
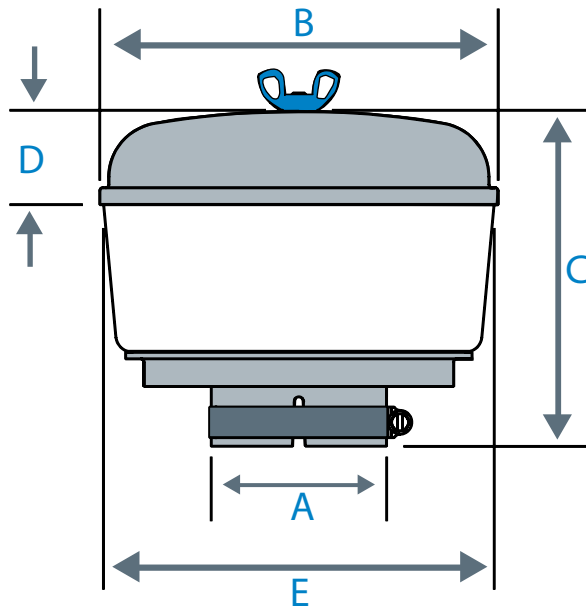

Full-View Pre-Cleaners Specifications

Entire F.V. Pre- Cleaner	--- Replacement ---		Inlet (ID/OD)				--- C ---		--- D ---		--- E ---		Weight		Max. Airflow CFM
	Cover	Bowl	A in	A mm	B in	B mm	C in	C mm	D in	D mm	E in	E mm	lbs	kg	
H002042	P020116	P020115	1.75	44	5.59	142	4.75	121	1.72	44	5.50	140	0.8	0.37	80
H002040	P020116	P020115	2.00	51	5.59	142	4.75	121	1.72	44	5.50	140	0.9	0.41	90
H001823 ¹	P020648	P020227	2.00	51	7.34	186	6.19	157	1.72	44	7.25	184	1.4	0.64	110
H001250	P020648	P020227	2.25	57	7.34	186	6.19	157	1.72	44	7.25	184	1.5	0.68	130
H001251	P020648	P020227	2.50	64	7.34	186	6.19	157	1.72	44	7.25	184	1.5	0.68	150
H001249	P020648	P020227	3.00	76	7.34	186	6.19	157	1.72	44	7.25	184	1.6	0.73	170
H000820 ¹	P016548	P016330	3.00	76	10.63	270	7.66	195	1.84	47	10.50	267	3.4	1.54	320
H000821	P016548	P016330	3.75	95	10.63	270	7.66	195	1.84	47	10.50	267	3.4	1.54	330
H000858	P016548	P016330	4.00	102	10.63	270	7.66	195	1.84	47	10.50	267	3.4	1.54	340
H002045 ¹	P020345	P020344	4.00	103	12.06	306	8.19	208	2.00	51	11.94	303	4.5	2.04	660
H000823	P016548	P016330	4.50	114	10.63	270	7.66	195	1.84	47	10.50	267	3.4	1.54	340
H002044 ¹	P020345	P020344	4.50	114	12.06	306	8.19	208	2.00	51	11.94	303	4.5	2.04	700
H002043	P020345	P020344	5.00	127	12.06	306	7.69	195	2.00	51	11.94	303	4.5	2.04	740
H002223	P104691	P158324	6.00	152	16.25	413	10.00	254	2.81	71	15.94	405	9.2	4.17	1300
H002224	P104691	P158324	7.00	178	16.25	413	10.00	254	2.81	71	15.94	405	9.2	4.17	1500

¹ - Heavy Duty Option

Extends Filter Life in Extremely Heavy Dust Conditions

The Donaspin™ Pre-Cleaner extends the life your air filter by removing up to 90% of the dirt and contaminant before it reaches the filter and ejecting it automatically via the exhaust system.

Donaspin is designed especially for equipment operating in very heavy dust/debris environments.



Application

- Vehicles: agricultural equipment, construction and waste haul vehicles
- For engine airflows of 305 to 800 cfm
- Recommended mounting: on top of the air inlet stack

Features

- Built-in louvers spin air to separate up to 90% of incoming dirt and debris from the air intake system
- Works as part of a scavenged flow system to continuously expel pre-cleaned contaminants through the exhaust flow
- Durable, corrosion-resistant steel construction
- High efficiency with low restriction
- No maintenance. Self-cleaning. No moving parts.
- Mounting clamp is included

How It Works

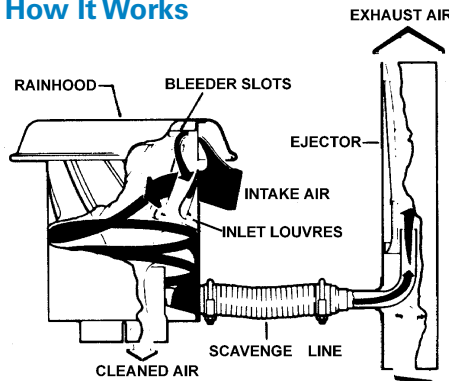

To create a scavenged flow system, combine the Donaspin with a Donaldson exhaust ejector and ejector check valve.

The Donaspin installed on this combine removes most of the incoming dirt, then directs the contaminant out of the system with the exhaust gases.

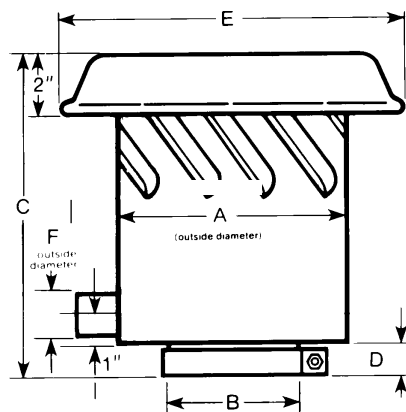

Donaspin™ Pre-Cleaner

Part Number	A		B (I.D.)		C		D		E		F		Rated Airflow @ 5" H ₂ O Added	Approx. Weight	
	in	mm	in	mm	in	mm	in	mm	in	mm	in	mm		lbs	kg
H001212	8.00	203	3.00	76	11.98	304	2.15	55	12.00	305	1.25	32	305	8	3.6
H001215	8.00	203	4.50	114	10.93	278	1.10	28	12.00	305	1.25	32	465	8	3.6
H001308	8.00	203	5.00	127	11.14	283	1.31	33	12.00	305	1.25	32	530	8	3.6
H001375	9.00	229	6.00	152	14.68	373	1.10	28	13.00	330	1.25	32	770	10	4.5

Two-stage Cleaning for Unexpected Dust/Moisture Conditions

When your truck is being used in heavier-than-anticipated dust or moisture conditions, you may not have to replace the entire air cleaner. The problem may be solved by adding a Donaldson in-line separator.

Installing this unit on your single-stage system **creates a two-stage air filtration system**. This enables an over-highway vehicle, which usually sees only light dust, to be easily and economically adapted to off-road medium to heavy dust conditions.

Applications

- **Vertical model:** On/off road, mounted on inlet tubing or cowl mounted directly to air cleaner
 - Compatible with engine airflows of 500 to 1500 cfm
- **Horizontal model:** On/off road, typically mounted underhood
 - Compatible with engine airflows of 100 to 1400 cfm

Features

- 80% water removal efficiency
- 70% dust removal efficiency

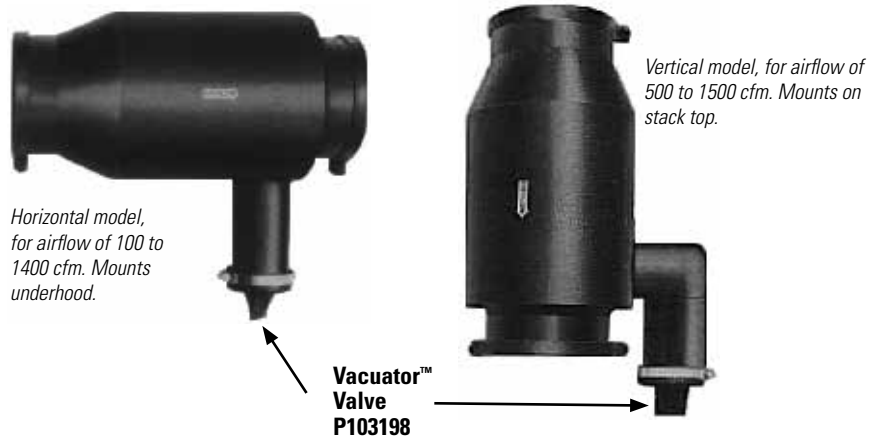

How It Works

1. When moisture — and/or dust-filled air — enters at one end, the built-in, stationary vanes cause the air to spin.
2. This spin creates centrifugal force, which pushes all moisture and dust to the outside wall where it separates from the air.
3. Moisture and dust are thrown into the Vacuator Valve tubing, then automatically released by the Vacuator Valve.
4. Clean air (acceptable for maximum filter life and engine performance) passes to the air cleaner.

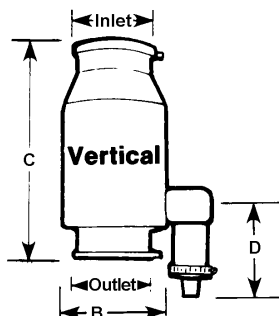
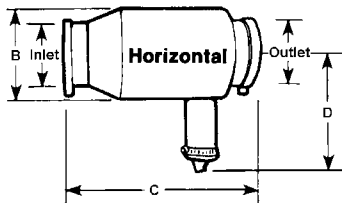
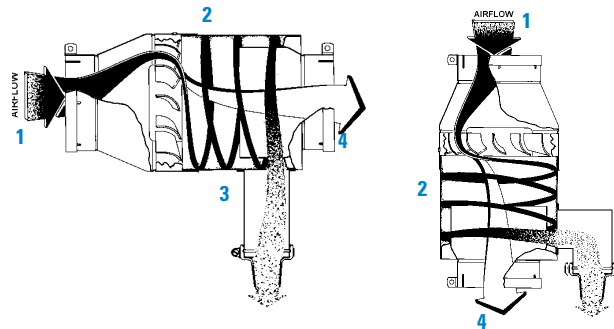

In-Line Separators

Part Number	CFM Range	Inlet		Outlet		Diameter (B)		Length (C)		D	
		in	mm	in	mm	in	mm	in	mm	in	mm
HORIZONTAL STYLE											
H001474	100-400	4 OD ¹	102 OD	4 OD	102 OD	5.50	140	11.50	292	7.18	182
H000875	500-1,000	6 ID ²	152 ID	6 ID	152 ID	8.56	217	17.25	438	11.58	294
H001906	700-1,400	7 ID	178 ID	7 ID	178 ID	9.59	244	17.0	432	12.02	305
VERTICAL STYLE											
H000878	500-1,100	6 ID	152 ID	6 ID	152 ID	8.56	217	17.25	438	7.80	198
H000886	750-1,100	7 ID	178 ID	7 ID	178 ID	8.56	217	17.25	438	7.80	198
H001220	900-1,500	8 OD	203 OD	8 ID	203 ID	9.59	244	17.0	432	4.56	115

1 - Outer diameter
2 - Inner diameter

Protection Against Rain and Debris Ingestion

- Protects engine air intake from rain, snow, birds, and other large contaminants
- Mounts on stack or directly to air cleaner for on-road and off-road equipment
- Four styles in a wide variety of sizes
- Installs easily with one clamp. Clamp included with hood on styles B, C and D



Style A



Style B



Style C



Style D

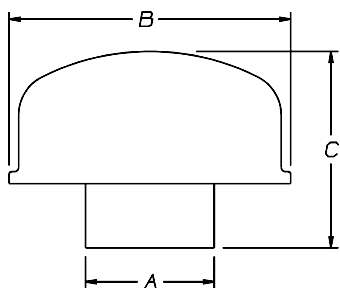

Inlet Hood — Style A¹

Part Number	Fits O.D. (A)		Hood Dia. (B)		Height (C)		Add to Stack		Mat'l	Weight	
	inch	mm	inch	mm	inch	mm	inch	mm		lbs	kgs
X002017	1.75	44	4.13	105	3.31	84	2.75	70	Metal	0.50	0.22
X002018	2.00	51	4.13	105	3.25	83	2.75	70	Metal	0.50	0.22
X002019	2.25	57	5.24	133	3.97	101	3.50	89	Metal	0.80	0.36
X001966	2.50	64	5.25	133	3.97	101	3.50	89	Metal	0.80	0.36
X002014	3.00	76	6.13	156	5.06	129	3.75	95	Metal	1.10	0.50
X001988	3.75	95	8.06	205	7.75	197	6.00	152	Metal	2.10	0.95
X002015	4.00	102	8.06	205	7.88	200	6.00	152	Metal	2.00	0.90

¹ - Clamps must be ordered separately for this style.

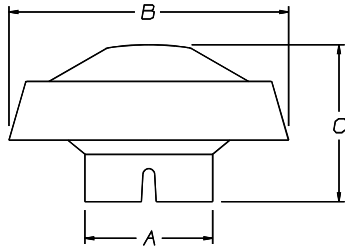

Inlet Hood — Style B

Part Number	Fits O.D. (A)		Hood Dia. (B)		Height (C)		Add to Stack		Mat'l	Weight	
	inch	mm	inch	mm	inch	mm	inch	mm		lbs	kgs
H002068	1.75	44	6.00	152	3.37	86	2.05	52	Plastic	0.20	0.09
H001377	2.00	51	6.00	152	3.31	84	2.50	64	Plastic	0.20	0.09
H001378	2.50	64	6.00	152	3.31	84	2.50	64	Plastic	0.20	0.09
H001379	3.00	76	6.00	152	3.31	84	2.50	64	Plastic	0.20	0.09

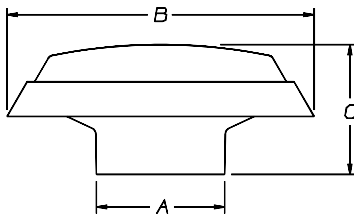

Inlet Hood — Style C

Part Number	Fits O.D. (A)		Hood Dia. (B)		Height (C)		Add to Stack		Mat'l	Weight	
	inch	mm	inch	mm	inch	mm	inch	mm		lbs	kgs
H001063	3.00	76	11.50	292	5.88	149	3.63	92	Plastic	1.10	0.50
H000466	3.75	95	11.50	292	5.13	130	3.63	92	Plastic	0.80	0.36
H000473 ²	3.75	95	11.50	292	5.13	130	3.63	92	Plastic	1.00	0.45
H000467	4.00	102	11.50	292	5.06	129	3.38	86	Plastic	0.90	0.40
H000472 ²	4.00	102	11.50	292	5.06	129	3.38	86	Plastic	1.00	0.45
H000468	4.50	114	11.50	292	4.88	124	3.38	86	Plastic	0.80	0.36
H000471 ²	4.50	114	11.50	292	4.88	124	3.38	86	Plastic	1.00	0.45
H000469	5.00	127	11.50	292	4.88	124	3.31	84	Plastic	0.80	0.36
H000470 ²	5.00	127	11.50	292	4.88	124	3.31	84	Plastic	1.00	0.45
H000605 ²	5.00	127	16.00	407	5.75	146	3.31	104	Plastic	1.80	0.80
H000604 ²	5.50	140	16.00	407	5.75	146	4.94	125	Plastic	1.80	0.80
H000606 ²	6.00	152	16.00	407	5.75	146	4.94	125	Plastic	1.80	0.80
H001756	6.00	152	13.00	330	4.06	103	2.69	68	Bright	1.50	0.68
H001948 ²	6.00	152	16.00	406	5.69	145	4.25	108	Bright	1.50	0.68
H001773	7.00	178	12.81	325	4.81	122	3.44	87	Bright	1.50	0.68
H001742	7.00	178	13.00	330	3.88	99	2.50	64	Bright	1.50	0.68
H000607 ²	7.00	178	16.00	406	5.75	146	4.09	104	Plastic	1.80	0.80
H001947 ²	7.00	178	16.00	406	5.69	145	4.25	108	Bright	1.50	0.68
H001053 ²	8.00	203	16.00	406	6.19	157	4.69	119	Plastic	1.80	0.80
H001946 ²	8.00	203	16.00	406	6.19	157	4.60	117	Bright	1.50	0.68

Air Inlet Hood Style C offers more models that provide added rain/water protection. While all inlet hoods offer top rain/water there are some that offer additional protection from splash on the underside of the hood.

2 - Hood has rain shroud on underside of hood style.

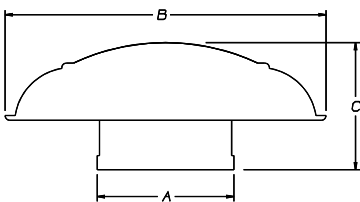

Inlet Hood — Style D

Part Number	Fits O.D. (A)		Hood Dia. (B)		Height (C)		Add to Stack		Mat'l	Weight	
	inch	mm	inch	mm	inch	mm	inch	mm		lbs	kgs
H000170	4.50	114	9.50	241	4.69	119	3.69	94	Metal	3.20	1.44
H000165	5.00	127	9.50	241	4.69	119	3.69	94	Metal	3.30	1.50
H000275	6.00	152	9.50	241	4.69	119	3.69	94	Metal	3.10	1.40
H000276 ²	6.00	152	9.50	241	4.69	119	3.69	94	Metal	3.20	1.44
H000339	7.03	179	17.00	432	6.75	171	5.75	146	Metal	4.60	2.08
H770082	10.00	256	15.98	406	7.42	188	5.28	134	Metal	5.0	2.27

W-Foot Mounting Bands Designed For Donaldson Air Cleaners

- Durable, corrosion-resistant, steel construction
- Fully engineered and tested to resist the adverse effects of vibration
- Mounting band feet are designed to ensure maximum torque pressure, continuously
- Air cleaners require minimum of two mounting bands per housing
- Gauge of steel increases as diameter of mounting band increases
- Bright stainless models available
- Bolt and nut included with mounting band



Most of our air cleaners with metal housings require two mounting bands.

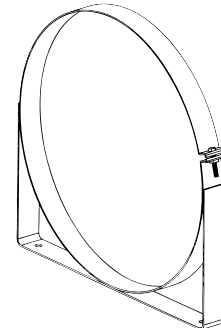

Two models (H770068, H770037) have different foot band compared to others.

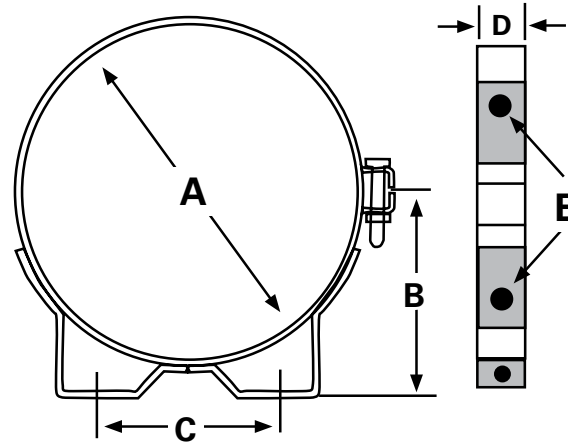

Air Cleaner Mounting Bands

Part Number	A		B		C		D		E		Weight		Max. Bolt Torque	
	inch	mm	inch	mm	inch	mm	inch	mm	inch	mm	lbs	kg	lbs-ft	N·m
P007189	4.00	102	2.56	65	2.50	64	.75	19	.31	8	0.30	0.14	1.50	2.03
P002348	5.25	133	3.19	81	3.25	83	.88	22	.34	9	0.70	0.32	1.50	2.03
P002351	6.00	152	3.56	90	3.25	83	1.00	25	.34	9	0.80	0.36	1.50	2.03
P007191	6.50	165	3.88	99	3.75	95	.88	22	.41	10	0.70	0.32	2.00	2.71
P004906	7.00	178	4.13	105	4.50	114	.88	22	.30	8	0.80	0.36	3.00	4.07
P003245	7.75	197	4.44	113	4.25	108	1.00	25	.34	9	0.90	0.41	3.50	4.75
P004307	8.00	203	4.50	114	4.25	108	1.00	25	.34	9	1.10	0.50	4.00	5.42
P004073	9.00	229	5.13	130	4.5	114	1.25	32	.45	11	1.50	0.68	4.00	5.42
P004076	10.19	259	5.75	146	5.00	127	1.25	32	.45	11	1.50	0.68	4.00	5.42
P004079	11.00	279	6.13	156	5.00	127	1.25	32	.45	11	1.70	0.77	4.00	5.42
H000349	11.81	300	6.88	175	6.00	152	1.50	38	.41	10	2.50	1.13	4.00	5.42
P013722	13.00	330	7.25	184	6.00	152	1.50	38	.41	10	2.80	1.50	4.00	5.42
P522439*	13.00	330	7.25	184	6.00	152	1.50	38	.41	10	2.80	1.50	4.00	5.42
H000350	14.00	356	8.13	207	8.00	203	1.50	38	.47	12	3.70	1.68	5.00	6.78
P016845	15.00	381	8.00	203	8.00	203	1.50	38	.47	12	4.10	1.86	6.00	8.14
P524552*	15.00	381	8.00	203	8.00	203	1.50	38	.47	12	4.10	1.86	6.00	8.14
H000351	16.00	406	9.13	232	10.00	254	1.50	38	.47	12	4.75	2.16	5.00	6.78
H770037	18.00	457	9.2	234	15.75	400	1.96	50	.55	14	5.25	2.38	5.00	6.78
H770068	21.5	546	10.97	279	19.29	490	1.96	50	.55	14	6.39	2.9	5.00	6.78

*Bright Stainless Model

Worm-Drive Hose Clamps

- Versatile clamps for wide size range of hose connections
- Made of strong, durable, noncorrosive stainless steel
- Inside of clamp is lined so that hose doesn't bulge through clamp holes
- Narrow band enables easy installation in confined areas



Lined Hose Clamp

Part Number	-- Min. to Max. Size -- inch	mm
P532919	9/16 – 13/16	14 – 21
P532920	11/16 – 15/16	17 – 24
P532921	13/16 – 1-1/16	21 – 27
P532923	13/16 – 1-1/2	21 – 38
P532924	13/16 – 1-3/4	21 – 44
P532922	15/16 – 1-1/4	29 – 32
P115200	1-9/16 – 2-1/2	40 – 62
P115201	2-1/16 – 3	52 – 76
P143422	2-13/16 – 3-3/4	71 – 95
P115202	3-5/16 – 4-1/4	84 – 108
P115203	4-5/16 – 5-1/4	109 – 133

Recommended application up to 40 in·lb torque

Donaldson lined hose clamps seal silicone and other soft hoses without damage. The inner liner extends under the perforations to protect the hose and prevents extrusions through the worm-gear perforations.

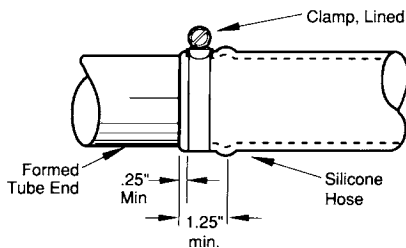

Initial torque on lined hose clamp should be 40 in·lb. If retorquing is required, limit to 20 in·lb.



Constant Torque Clamp

Part Number	-- Min. to Max. Size -- inch	mm
P532925	2-1/4 – 3-1/8	57 – 79
P532926	2-3/4 – 3-5/8	70 – 92
P532927	3-1/4 – 4-1/8	83 – 105
P532928	3-3/4 – 4-5/8	95 – 117
P532929	4-1/4 – 5-1/8	108 – 130

Recommended application up to 90 in·lb torque

Donaldson constant torque lined clamps are the best choice for systems where clamps cannot be retightened and have difficult access. Perfect for applications requiring higher torque, large diameters, temperature extremes, or where expansions and contractions within the system are common. This clamp is a good choice for critical coolant and charge-air connections.



High Torque Clamp

Part Number	-- Min. to Max. Size -- inch	mm
P636718	1-1/4 – 2-1/8	32 – 54
P636719	2-1/4 – 3-1/8	57 – 79
P544076	3-1/4 – 4-1/8	82 – 105
P115204	4-1/4 – 5-1/8	108 – 130
P115205	5-1/4 – 6-1/8	133 – 156
P115206	6-1/4 – 7-1/8	159 – 181
P115207	7-1/4 – 8-1/8	184 – 206
P115208	8-1/4 – 9-1/8	210 – 232
P115209	10-1/4 – 11-1/8	260 – 286

Recommended application up to 150 in·lb torque

This EXTRA heavy-duty clamp ensures total protection against leakage . . . eliminates the need for double clamping.

T-Bolt Clamps



Part Number	Nominal I.D. ¹	Min. to Max. Size inch	mm
P148337	2.00	2.25 – 2.53	57 – 64
P148338	2.25	2.50 – 2.78	63 – 70
P148339	2.50	2.81 – 3.09	71 – 78
P148340	2.75	3.06 – 3.34	78 – 85
P148341	3.00	3.31 – 3.59	84 – 91
P148342	3.50	3.81 – 4.09	98 – 104
P148343	4.00	4.31 – 4.59	109 – 116
P148344	4.50	4.81 – 5.09	122 – 129
P148345	5.00	5.31 – 5.59	135 – 142
P148346	5.50	5.94 – 6.21	151 – 158
P148347	6.00	6.38 – 6.65	162 – 169
P148348	7.00	7.38 – 7.78	187 – 198
P148349	8.00	8.25 – 8.56	210 – 217
P629991	8.25	8.50 – 8.81	216 – 224
P148350	10.00	10.50 – 10.91	267 – 277

¹ - Nominal I.D. dimension, shown in inches, corresponds to I.D. dimension of rubber part being clamped.

Recommended application up to 50 in·lb torque

Filter Service Indicators, Switches, and Sensors Maximize Filter Life

Trusted Filter Minder® Indicators and Switches — now part of Donaldson!



Replacing filters based on restriction readings can reduce your filter maintenance costs significantly. Visual inspection of air filters is not adequate and should not be used to determine service life. Filters that appear very dirty may still contain a great amount of life.

Over-servicing and excessive handling of filters can result in serious consequences: filter damage, improper installation, intake contamination from ambient dust, and increased service cost, time and material. In contrast, filter service based on restriction readings can help you obtain the longest life possible from the filter, provide the best engine protection, and decrease environmental impact by disposing of fewer filters.

Restriction Readings: Where & When

Restriction readings are normally taken at the air cleaner on the clean side of the air filter. If the air cleaner does not have a restriction tap, a tap can be added to the system in the ducting between the air cleaner and engine inlet. Check with the engine manufacturer for intake restriction requirements and measurement limits.



Filter service indicators are very effective when mounted *on the outlet tube of the air cleaner* (see The Informer™ above). This gives the operator constant and accurate visibility of filter life.

Engine Manufacturers Recommended Restriction Limits

Maximum allowable restriction limits are set by engine manufacturers. If your maximum limit is unknown contact your engine manufacturer. To accurately measure the maximum system restriction, all engines need to be operated at high idle and under full load. This will cause engines that boost airflow by using turbo chargers or superchargers to operate under full boost pressure causing maximum airflow to occur. Actual airflow during use may vary depending on multiple factors, including specific product configuration, external conditions and application.

Choose Restriction Measurement Tools that Best Fit Your Applications

Donaldson offers a variety of restriction measuring devices that help you get the most from your filters. All measure restriction in inches of water vacuum. They are resistant to vibration, breakage, weather, corrosion, dust, and dirt to assure reliable filter restriction readings.

Restriction measurement tools are available in the following categories: Graduated Indicators, Single Position Indicators, Visual Indicator and Switch, Switch Only, Sensors, and LED Displays.

Graduated Indicators

Graduated indicators, which can be mounted on the air cleaner or in the dashboard, provide restriction readings in inches of water vacuum. A clear window shows the restriction level and when to change the filter.

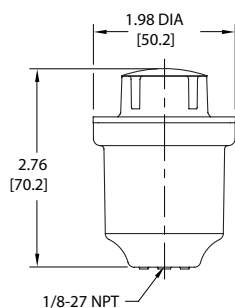

Filter Minder® Threaded

Part Number	Restriction Limit	Thread Size
135501-00820	20" H ₂ O/5 kPa	1/8 NPT
135501-00825	25" H ₂ O/6.2 kPa	1/8 NPT
136501-00520	20" H ₂ O/5 kPa	3/8-24 UNF
136501-00525	25" H ₂ O/6.2 kPa	3/8-24 UNF

This unit continuously monitors air filter restriction. The clear window fills with yellow as filter restriction increases. The indicator locks at several increments. The filter should be changed when the indicator reaches the red zone. Reset the indicator by pushing the yellow reset button.

It can be mounted directly to the air cleaner housing in any orientation. An adaptor fitting is available, if required. Operating temperature: -40 °F to +250 °F (-40 °C to +121 °C).

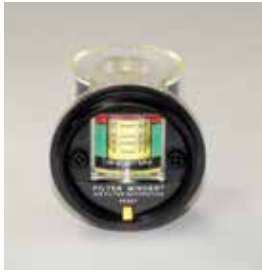

Filter Minder® Dash Mount

Part Number	Restriction Limit
168501-00220	20" H ₂ O/5 kPa
168501-00225	25" H ₂ O/6.2 kPa

This unit continuously monitors air filter restriction. It can be mounted in the panel or dash for convenience of the driver or operator. Illuminated version is available. Bezels in chrome, black, or green. Air cleaner fittings and vacuum hose are available for order, separately. Operating temperature: -40 °F to +250 °F (-40 °C to +121 °C)

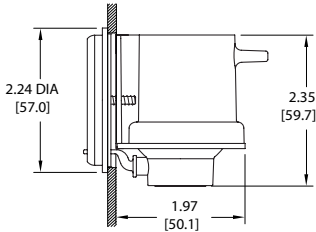

Service Gauge Dash Mount

Part Number	Restriction Limit	Kit Contents
X002730	30" H ₂ O/7.5 kPa	nuts, mounting bracket, and installation instructions
X002700	60" H ₂ O/15 kPa	restriction tap fitting (P112257), nuts, mounting bracket, and installation instructions

This unit reads restriction while the engine is running. It installs on an instrument panel or wherever operator can easily see the dial. Mounts into a 2-5/8" diameter hole. Hoses are available for order, separately.

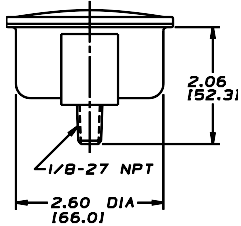

The Informer™

Part Number	Restriction Limit	Kit (gauge and fitting)
X002278	20" H ₂ O/5 kPa	X002103
X002277	25" H ₂ O/6.2 kPa	X002102
X002275	30" H ₂ O/7.5 kPa	X002101

This unit continuously monitors air filter restriction. A clear window turns red when maximum restriction has been reached. The reset button is on top.

Kit includes full installation instructions and a P100089 safety filter fitting. For remote mounting, order a P105168 flange and a P105622 90° elbow.

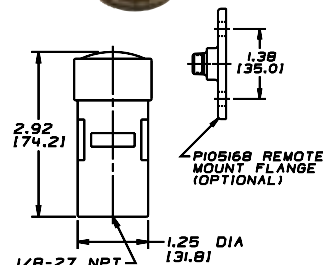

Single Position Indicators

Single position indicators continuously monitor air filter restriction. Also known as Go/No-Go indicators, these units show whether maximum air filter restriction has or has not been reached. When maximum restriction has been reached, the unit either changes color to red, or displays an orange or red flag, depending on the model.



Filter Minder®

Part Number	Restriction Limit
175501-00125	25" H ₂ O/6.2 kPa
175501-00220	20" H ₂ O/5 kPa

The window turns red when the maximum air filter restriction has been reached. Indicator is reset by pushing the yellow button.

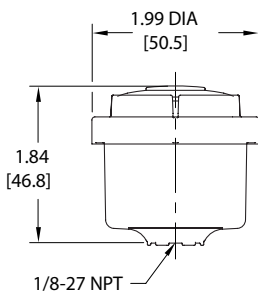

It can be mounted directly to the air cleaner housing in any orientation. An adaptor fitting is available if required. Operating temperature: -40 °F to +250 °F (-40 °C to +121 °C).



The Mini-Informer

Part Number	Restriction Limit	Gauge and Grommet
X007335	25" H ₂ O/6.2 kPa	X007276

The Mini-Informer restriction gauge is designed to mount in the plastic air cleaners of passenger cars, light trucks, and sport utility vehicles.

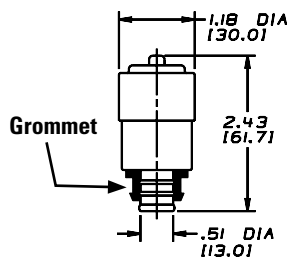

Through the clear window, a green flag shows when air filter restriction is below the service point. When the restriction reaches its limits, an orange flag imprinted with "Change Filter" pops up. The reset button is on top.

The Mini-Informer mounts in the air cleaner ducting in a rubber grommet.



Servi-Signal™ Mini Indicator

Part Number	Restriction Limit	Kit (gauge and fitting)
X002250	15" H ₂ O/ 3.7 kPa	X002350
X002251	20" H ₂ O/ 5 kPa	X002351
X002252	25" H ₂ O/ 6.2 kPa	X002352
X002254	30" H ₂ O/ 7.5 kPa	X002354

Small enough to fit just about anywhere (only 1.66" high), the Donaldson ServiSignal shows a highly visible, bright red flag in the full-view window when restriction limit is reached. Resets manually via top button after air cleaner service.

Kit includes 1/8" NPT threaded brass fitting for mounting on the air cleaner. For remote mount, also order P105168 flange. Hoses are available for order, separately.

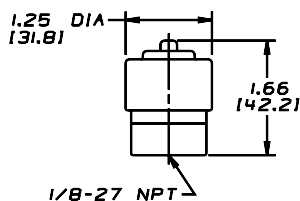

1/8-27 NPT

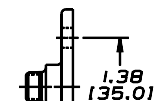

P105168 REMOTE MOUNT FLANGE (OPTIONAL)



Visual Restriction Indicator

Part Number	Restriction Limit	Kit (gauge and fitting)
X002215	15" H ₂ O/ 3.7 kPa	X002315
X002220	20" H ₂ O/ 5 kPa	X002320
X002225	25" H ₂ O/ 6.2 kPa	X002325
X002230	30" H ₂ O/ 7.5 kPa	X002330

This indicator can be mounted directly on the air cleaner or remotely on the instrument panel or firewall. When restriction limit is reached and filter service is needed, easily-visible, bright red shows through the full-view window. After the filter is serviced, reset via rubber button on top. For remote mount, also order a flange, P105168. Hoses are available for order, separately.

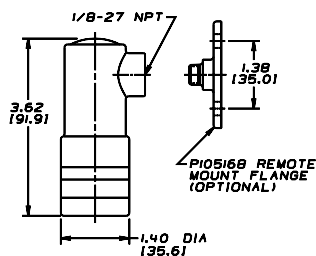

P105168 REMOTE MOUNT FLANGE (OPTIONAL)

Switches

Air Filter switches continuously monitor air filter restriction. There are two types of switches: Switch Only and Visual Indicator and Switch. Both types send electrical signals to remote “time to service filter” lights, which are usually located in the equipment cab.

Switch Only

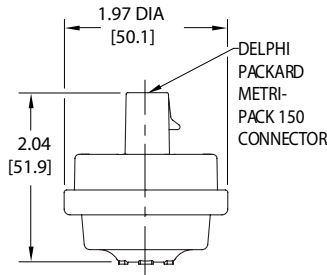

Filter Minder

Part Number	Restriction Limit	Switch	Thread Size
195389-00120	20" H ₂ O/5 kPa	N/O	1/8 NPT
195389-00125	25" H ₂ O/6.2 kPa	N/O	1/8 NPT
196398-11120	20" H ₂ O/5 kPa	N/C	3/8-24 UNF
196398-11125	25" H ₂ O/6.2 kPa	N/C	3/8-24 UNF

These non-locking air switches trigger an air filter warning light via the engine computer or directly to the warning light. They are used for air filter monitoring on diesel, gas, and alternate fuel engines, as well as other applications where low vacuum/pressure monitoring is required.

- Heavy duty, self-cleaning design for heavy-duty service.
- External shield, barrier filter, and labyrinth protects the switch.

It can be mounted directly to the air cleaner housing in any orientation. An adaptor fitting is available, if required. Operating temperature: -40 °F to +250 °F (-40 °C to +121 °C).

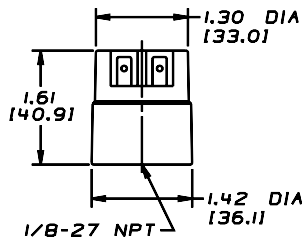

Electrical Indicator

Part Number	Restriction Limit
X770037	15" H ₂ O/ 3.7 kPa
X770050	20" H ₂ O/ 5.0 kPa
X770062	25" H ₂ O/ 6.2 kPa
X770075	30" H ₂ O/ 7.5 kPa

Our electrical indicator is designed for a variety of on- and off-highway applications within operating temperatures of -40 °F to +212 °F (-40 °C to +100 °C). When restriction level reaches the maximum recommended limit, an electrical signal activates a light, a buzzer, or a computer — it's your choice. The indicator automatically resets itself after the filter is serviced.

- 12-24 Volts. Maximum load: 6 watts (light or buzzer)
- Contacts have no polarity
- Switch contacts are normally in the open position
- Quick connectors and light, buzzer, or computer must be purchased separately

Visual Indicator and Switch

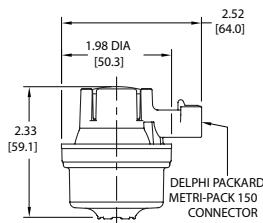

Filter Minder® Single Position Indicator and Switch

Part Number	Restriction Limit	Switch	Thread Size
175578-10225	25" H ₂ O/ 6.2 kPa	N/O	1/8 NPT
175587-13020	20" H ₂ O/ 5 kPa	N/C	1/8 NPT

This unit is a combination single position indicator and switch. When the maximum recommended air filter restriction has been reached, the window turns red and a signal is sent to the filter warning light on the dash or engine computer. The warning light locks on until the indicator is reset by pressing the yellow button. It operates in temperatures of -40 °F to +250 °F (-40 °C to +121 °C) and can be mounted in any orientation.

Wire harness adapters are available for order, separately.

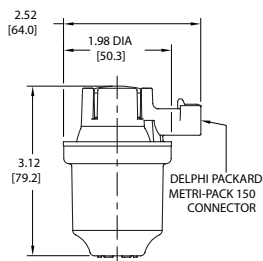

Filter Minder® Graduated Indicator and Switch

Part Number	Restriction Limit	Switch	Thread Size
135578-08420	20" H ₂ O/ 5 kPa	N/O	1/8 NPT
135578-08425	25" H ₂ O/ 6.2 kPa	N/O	1/8 NPT
135587-09225	25" H ₂ O/ 6.2 kPa	N/C	1/8 NPT
136578-07820	20" H ₂ O/ 5 kPa	N/O	3/8-24 UNF
136578-07825	25" H ₂ O/ 6.2 kPa	N/O	3/8-24 UNF

This unit is a combination graduated indicator and switch. The yellow indicator moves up in the window and locks at the highest air filter restriction. When it reaches the red zone, or highest recommended restriction, it sends a signal to the filter warning light on the dash or engine computer to record as a diagnostic fault. The warning light locks on until the indicator is reset by pressing the yellow button. It operates in temperatures of -40 °F to +250 °F (-40 °C to +121 °C) and can be mounted in any orientation.

Wire harness adapters are available for order, separately.

SafetySignal™ Wing Nut Indicator for Safety Filter

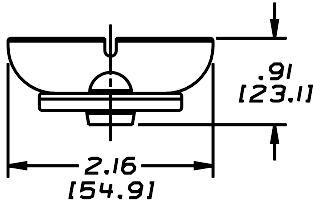

SafetySignal

Part Number	Air Cleaner	Thread Size	Included Washer
X004814	FTG 13" & 15", FHG12" & 14", FVG16"	7/16" – 20 UNF	P111551
X004815	FTG11	7/16" – 20 UNF	P101872
X004816	FVG14-16", STG12-16" & All SRG models	1/2" – 13 UNC	P105740

The SafetySignal service indicator replaces the wing nut on the metal end cap safety filters and constantly monitors air restriction. When service is required, it locks red and can be reset after service. The SafetySignal requires no special fittings or adapters. Donaldson safety filters are designed to last through multiple primary filter change-outs. The SafetySignal helps save time and money by preventing over-servicing.

Sensors

Low pressure sensors can monitor vacuum or pressure, and excel at maintaining accuracy across a wide temperature range. They have an integrated AMPSEAL 16 electrical connection, are available in multiple vacuum or pressure settings, and can be furnished with custom mounting. It operates in temperatures of -40 °F to +257 °F (-40 °C to +125 °C)

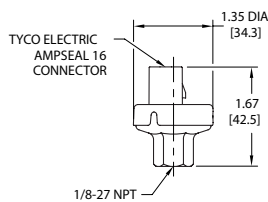

Filter Minder® Low Pressure Sensor

Part Number	Restriction Limit	Thread Size
115375-00002	2" H ₂ O/ 0.5 kPa	1/8 NPT
115305-00005	5" H ₂ O/ 1.25 kPa	1/8 NPT
115305-00040	40" H ₂ O/ 10 kPa	1/8 NPT

Restriction Tap Fittings

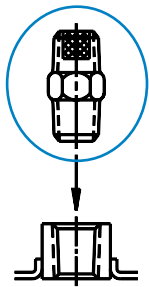

P100089

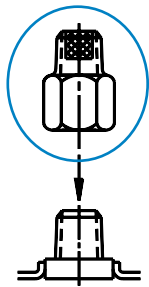

P122067



P633880



P633881

Restriction Indicator Fitting

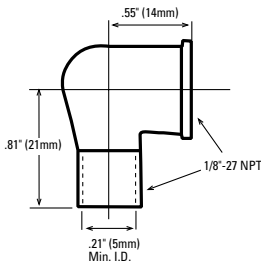

P105622

Fittings

Part Number	Description
P100089	1/8-27; .44" (11mm) hex nut; Male threads both ends; internal sintered bronze safety filter
P122067	1/8-27; Female threads on one end, male threads on opposite end; internal sintered bronze safety filter
P105622	1/8-27; 90° elbow with threaded end
P633880	1/8-27 NPT x 3/8-24 UNF with Filter and Orifice
P633881	1/8-27 NPT Male to Hose Barb with Filter

Restriction Tap Sleeve

Install this sleeve in your intake system to convert from scheduled maintenance to more economical restriction maintenance practices.



Restriction Tap Sleeves

Part Number	Fits Pipe O.D.
P521639	5" / 127mm
P521641	6" / 152mm

Water Manometer Kit

The Donaldson water manometer kit includes the manometer (flexible tubing), green dye, and full instructions. Manometer, range 18-0-18 in., 17-1/2 oz. mercury.



P134534

Magnets conveniently hold top and bottom ends of manometer to side of equipment or vehicle. Special shut-off valve eliminates the need to empty water after use.

LED Display

Connect a Filter Minder LED Display to a Filter Minder® sensor to read filter restriction level in the cab.



P633871



P633873

Filter Minder LED Displays

Part Number	Display Type
P633871	Round
P633872	Round, Sealed
P633873	Square

Wire Harness Adapters

Wire harness adapters (flying leads) can accommodate most applications.



P633874



P633875

Filter Minder Wire Harness Adapters

Part Number	Application
P633874	AMP for Low Pressure Sensor
P633875	Packard for Switches

EPDM Hose

Hose is available in lengths of up to 20 feet.



P633876



P633878

Filter Minder EPDM Hose

Part Number	Length
P633876	3'
P633877	20'
P633878	10'

Remote Mount Bracket

The remote mount bracket increases mounting flexibility.



Filter Minder Remote Mount Bracket

Part Number	Application
P633879	3/8–24 UNF with O-ring

90° Rubber Elbows & Reducing/Expanding Elbows



These flexible rubber adapters and elbows have smooth radii and inside surfaces to minimize flow resistance within the air intake system. These rubber products are heavy-duty.

Larger elbows (5"/125mm) are ribbed or compounded for added strength and durability. All Donaldson rubber products meet ASTM standards.

- Resist tears, punctures and vacuum collapse
- Absorb vibration
- Reduce intake noise levels under severe conditions
- Material: EPDM rubber construction
- Temperature range: -40 °F (-40 °C) to +212 °F (+100 °C)
- Do not use after turbo
- Application tip: A minimum 1½" of metal piping should be inserted into the rubber fitting.

90° Elbows

Inner Dia. (A) in mm	Center Height (B) in mm	Radius (R) in mm	Part Number
2.00 51	3.50 76	2.00 51	P105529
2.25 57	3.75 95	2.25 57	P105530
2.50 64	4.00 102	2.50 64	P105531
3.00 76	5.25 133	3.75 95	P105532
3.50 89	5.50 140	4.00 102	P114318
4.00 102	5.75 146	4.50 114	P105533
4.50 114	5.50 140	3.50 89	P113733
5.00 127	6.12 155	4.50 114	P107844
5.50 140	6.50 171	4.63 118	P105534
6.00 152	7.00 179	5.00 127	P105535
7.00 179	7.56 192	5.56 141	P105536
8.00 203	8.50 216	6.50 165	P112605
10.00 254	10.50 267	8.50 216	P114314

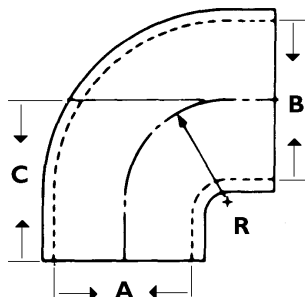
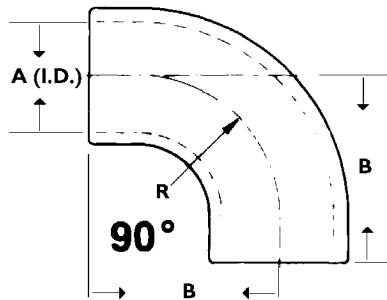

90° Elbow Reducers/Expanders

Inner Dia. (A) in mm	Inner Dia. (B) in mm	Center Height (C) in mm	Radius (R) in mm	Part Number
3.00 76	3.50 89	3.50 89	2.25 57	P123462
	4.00 102	4.50 114	3.00 76	P536163
4.00 102	5.00 127	6.00 152	3.75 95	P121482
	6.00 152	4.74 120	3.50 89	P537468
	6.00 152	6.00 152	4.25 108	P143895
5.00 127	7.00 179	6.25 159	4.25 108	P159820
	6.00 152	6.75 171	5.00 127	P117724
	7.00 179	6.25 159	4.38 111	P128990
7.0 179	6.0 152	9.0 229	4.37 111	P215307

45° Rubber Elbows, Reducing/Expanding Elbows and Hump Reducers

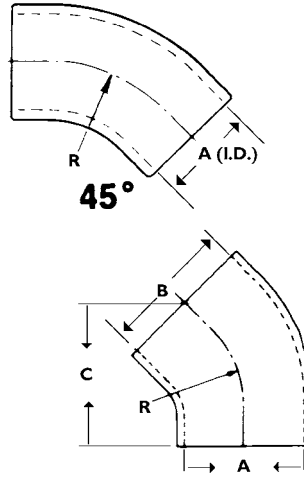

45° Elbows

Inner Dia. (A) in	mm	Radius (R) in	mm	Part Number
2.00	51	2.00	51	P105541
2.25	57	2.25	57	P105542
2.50	64	2.50	64	P105543
3.00	76	3.75	95	P105544
3.50	89	3.50	89	P109331
4.00	102	4.25	108	P105545
4.50	114	3.50	89	P114316
5.00	127	4.50	114	P109021
5.50	140	4.75	121	P105546
6.00	152	5.00	127	P105547
7.00	178	5.56	141	P105548
8.00	203	6.50	165	P112606
10.00	254	8.50	216	P114313

45° Elbow Reducers/Expanders

Inner Dia. (A) in	mm	Inner Dia. (B) in	mm	Center Height (C) in	mm	Radius (R) in	mm	Part Number
5.50	140	6.00	152	6.44	164	4.88	124	P133338
6.00	152	7.00	179	7.38	187	5.31	135	P133339

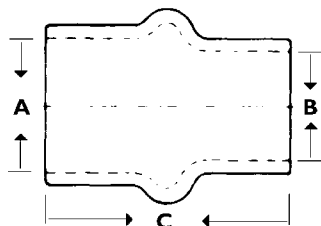

Rubber Hump Reducers/Expanders

Inner Dia. (A) in	mm	Inner Dia. (B) in	mm	Length (C) in	mm	Part Number
3.00	76	2.50	64	4.50	114	P102820
		2.75	70	3.50	89	P520883
3.50	87	3.00	76	5.00	127	P101290
		2.75	70	4.00	102	P520882
4.00	102	2.75	70	4.00	102	P520884
		3.00	76	5.25	133	P101291
		3.50	87	5.25	133	P101292
4.50	114	4.00	102	6.00	152	P540256
5.00	127	4.00	102	6.00	152	P101293
		4.50	114	6.25	159	P604045 ¹
5.50	140	4.00	102	6.00	152	P101891
		5.00	127	6.00	152	P103516
6.00	152	5.00	127	6.00	152	P112611
		5.50	140	6.00	152	P101294
		5.00	127	7.00	179	P136494
7.00	179	5.50	140	7.00	179	P126530
		6.00	152	6.00	152	P112610
		6.00	152	6.00	152	P129660
8.00	203	6.00	152	6.00	152	P114315
		7.00	179	6.00	152	P112609
		8.00	203	6.00	152	P112607

1 - Use clamp size for nominal 5" (127mm) I.D. each end.

Rubber Straight Humps, Reducing/Expanders & Cobra Adapters



Rubber Straight Humps

Inner Dia. (A)		Length (B)		Part Number
in	mm	in	mm	
3.00	76	5.30	135	P105608
3.50	89	5.25	133	P114319
4.00	102	5.25	133	P105609
4.50	114	6.00	152	P114317
5.00	127	6.00	152	P105610
5.50	140	6.00	152	P105611
6.00	152	7.00	179	P105612
7.00	179	7.00	179	P105613
8.00	203	5.00	127	P112608
10.00	254	6.00	152	P111414

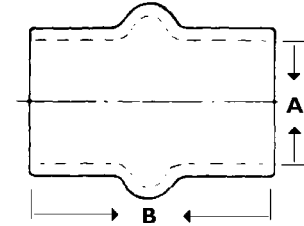

Rubber Reducers / Expanders

Inner Dia. (A)		Inner Dia. (B)		Length (C)		Part Number
in	mm	in	mm	in	mm	
2.00	51	1.50	38	2.50	64	P104087
		1.75	44			P102948
2.25	57	2.00	51	2.50	64	P104088
2.50	64	2.00	51	2.50	64	P104089
		2.25	57			P104090

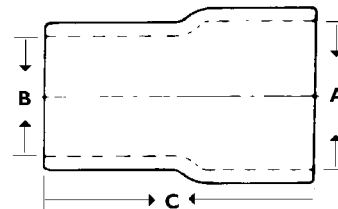

90° Cobra Adapters

Inner Dia. (A)		Inner Dia. (C)		Length (B)		(D)		Durometer	Part Number
in	mm	in	mm	in	mm	in	mm		
2.75	70	4.00	102	6.50	165	1.81	46	70	P600328
3.00	76	3.00	76	5.22	133	1.91	49	70	P547694
4.00	102	4.00	102	6.44	164	2.69	68	70	P600325
		4.00	102	6.44	164	2.69	68	80	P626161
		4.00	102	6.44	164	3.19	81	70	P600326
		5.00	127	6.44	164	3.19	81	70	P600327

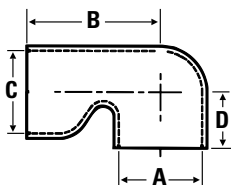

Silicone Charge Air Connectors Isolate Intake Piping Vibration Durable and Easy To Install

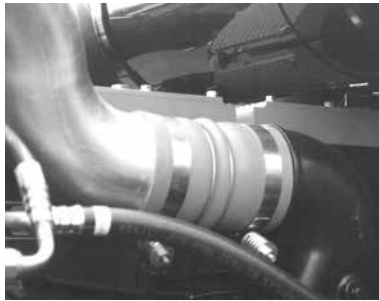

Our three styles of charge air connectors are designed to ease connections in air intake system piping. They compensate for slight misalignment and isolate vibration between hose connections. The silicone elastomer material resists chemicals, steam, ozone, and coolants that are normally found in any engine operating environment.

All three charge air connectors are for installation on the pressure side with maximum operating temperatures up to 500 °F (260 °C). They are orange to be easily identifiable and to signify that they are tolerant of high temperatures. They carry a one-year warranty.



Connectors/Sleeves — 50 psi*

Inner Dia. in	mm	Length in	mm	Part Number
2.00	51	36.00	914	P532948
2.25	57	36.00	914	P532949
2.50	64	36.00	914	P532950
3.00	76	36.00	914	P532951
3.38	86	3.50	89	P532952
		6.00	152	P532953
		36.00	914	P532954
3.50	89	3.50	89	P532956
		4.50	114	P532957
		36.00	914	P532958
4.00	102	36.00	914	P532959

* working pressure

Hump Hose Connectors — 40 psi*

Inner Dia. in	mm	Length in	mm	Part Number
2.50	66	5.50	140	P532960
2.75	70	4.25	108	P532961
3.00	76	4.38	111	P532962

* working pressure

4-Ply Bellows — 40 psi*

Inner Dia. in	mm	Length in	mm	No. of Rings	Part Number
3.50	89	6.00	152	3	P535572
4.00	102	6.00	152	0	P532943
		6.00	152	2	P535571
		6.00	152	3	P532944
		7.50	191	3	P532945
8.00	203	3	3	P535573	

* working pressure

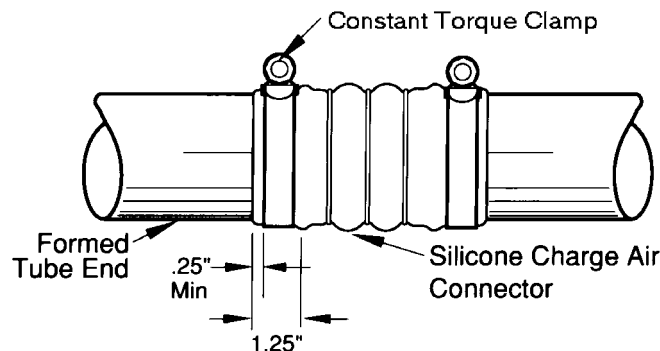

Use the illustration as a guide for installing your charge air connector. For proper installation, use Donaldson Constant Torque clamps to retain clamp load. Torque to 70-75 in·lb.

Vacuator™ Valves Automatically Expel Dust and Water

The Vacuator Valve, standard on the majority of Donaldson air cleaners, is an important part of the functionality of the air cleaner. It is an integral part of the pre-cleaning stage on two-stage air cleaners.

The dust cup, where pre-cleaned dust is collected, is normally under a slight vacuum when the engine is running. The normal engine pulsing of the vacuum causes the Vacuator Valve to open and close. This action automatically expels any collected dust and water. The Vacuator Valve also unloads when the engine is stopped.

The Donaldson Vacuator Valve, also known as VacValve, is made in a variety of sizes and shapes to fit various applications. The Donaldson part number is molded into each part for easy identification.



If your air cleaner is equipped with a Donaldson Vacuator™ Valve, make sure your routine filter service includes checking it to make sure it's in good condition and not plugged. If the Vacuator Valve is plugged, clean it.

For the longest filter service life, replace damaged or missing Vacuator Valves immediately!

If your valve is cracked, torn, remains open, or is missing, dust particles that are normally expelled can deposit themselves onto the filter and will shorten air filter service life. Replace it!

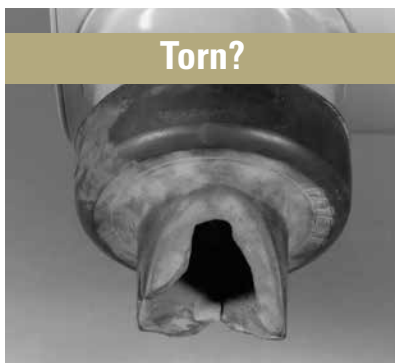
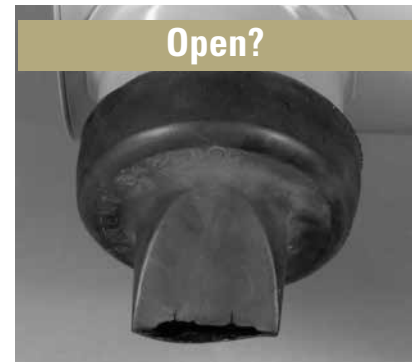
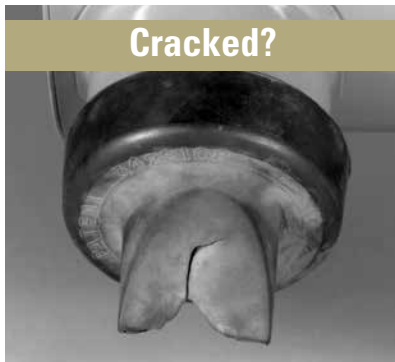



The Donaldson Vacuator™ Valve can be found on the majority of Donaldson air cleaners.

Application Notes

For proper operation, the Vacuator Valve should be located at the lowest point on the air cleaner or dust cup pointing down.

Never paint the Vacuator Valve. Solvents and chemicals will shorten the usable life.

If the Vacuator Valve is torn, shredded or turned inside out, its durometer may be too soft for the application. Choose a model with a harder durometer (higher number). Conversely, if the Vacuator Valve doesn't empty itself properly, the durometer may be too hard. Choose one with a softer durometer (lower number.)



Vacuator™ Valves

Part Number	Diameter in	Diameter mm	Durometer	Used on Air Cleaner Styles
P103198	3.0	76	40	FRG 10", 12", 14" and 16"; FHG 10", 12", 14" and 16"; FTG; FWA 5" – 16"; FWG 4" – 16"; SRG; In-line Water Separators
P105220	3.0	76	60	FRG 18"; FHG 8"; FVG160587
P106593	3.0	76	60	FHG 6" – 8"; High Pulsation Models
P112803	3.0	76	40	FHG 6" – 8"; PSD 10", PSD 12"; SBG 14" – 16"; SDG; STG 12" – 16"
P149099	1.0	25	60	ERA; EBA; EBB; ECG
P158914	2.0	51	50	XRB, FKB; PSD 8"; PSD 9"; FPG 6" and 8"; FRG 5" – 9", 11"; FHG 5"; FWG; FWA; Moisture Skimmers
P522958	2.0	51	60	FPG 4" – 5"; FHG
P525956	1.0	25	60	EPG 11", 13", 15"
P617632	1.57	40	50	PSD 08"
P776008	2.0	51	60	FPG 9", 10" Twist-off cover; FRG 10", 13", and 15"

Dust Dumpa Tube Extension For PSD, SRG, STG & SSG Air Cleaners



Replacement to Your Existing Dust Cup Assembly

Application

- Donaldson SRG, SSG, STG and PowerCore® PSD Air Cleaners

How It Works

When installed on the dust cups on the lower assembly, the rubber connector vibrates during normal vehicle operation and gravity expels the pre-cleaned dust.

Features

- Improves dust evacuation from the air cleaner
- Clear tube allows for visual inspection of dust collection
- Improves safety of the air cleaner inspection process by eliminating the need for ladders or elevated platforms for daily inspections
- Allows operators to perform walk around inspections
- Keeps operators and maintenance personnel away from the nuisance dust normally encountered during air cleaner servicing operations.
- Improves vehicle up-time by minimizing pre/post-shift air cleaner inspections, thus facilitating increased air cleaner service intervals.
- Reduces air cleaner inspection time
- Ships fully assembled
- Proper conversion requires drop down tube for every dust cup



If the above maintenance practice looks familiar, adding the X006561 Dust Dumpa extension to the dust cups of the air cleaner will save you maintenance time and will minimize your employees exposure to nuisance dust during service.

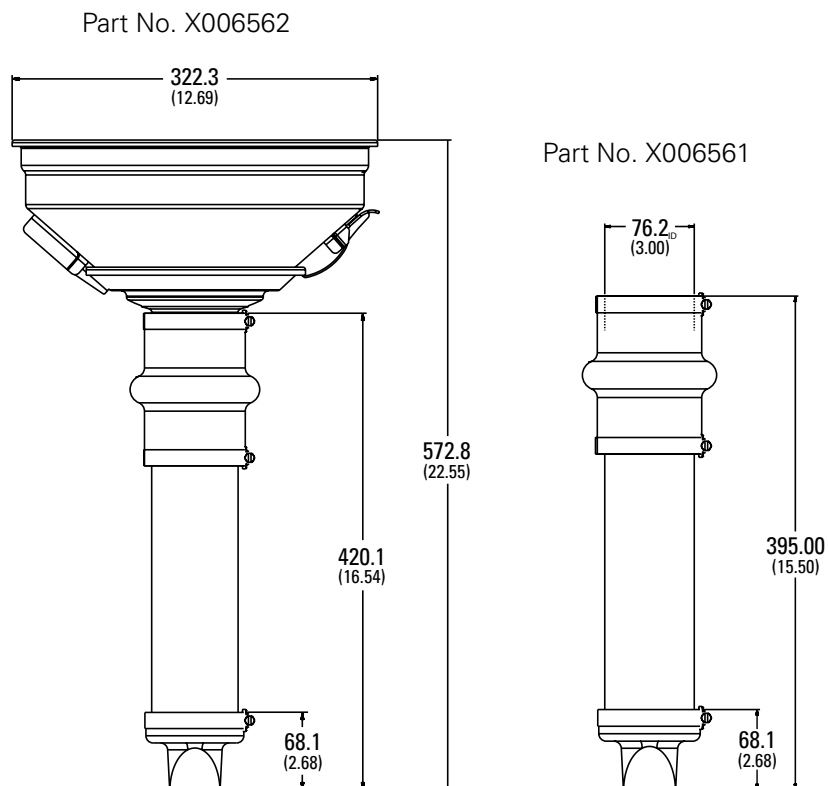

Available for SRG and SSG Air Cleaners



Three kits are required for S Series dual outlet models. For proper performance all dust cups must have the new Dust Dumpa installed.

Dust Dumpa applied to PSD PowerCore® Air Cleaners



Dust Dumpa + PSD air cleaners extended the filter service life for a geothermal drill rig in Australia.



Components For Scavenged Air Systems — Exhaust Ejectors and Check Valves

Donaldson exhaust ejectors and check valves are key components to creating a scavenged or aspirated air system. The ejector is used with Donaldson Donaspin™ or Strata™ Cap pre-cleaners, Strata™ systems, or PowerCore® PSD air cleaners.

A scavenged air system is typically used in off-highway equipment to extend air filter life. The exhaust ejector mounts as a stack at the end of exhaust system. It is recommended that the stack be covered with a curved exhaust stack or rain cap.

The redesigned ejector line offers a shorter length tube than our original standard and expanded ID offerings. With less space to work with, the new offering may work in applications where the previous models did not fit.

----- Basic Scavenged Air System -----

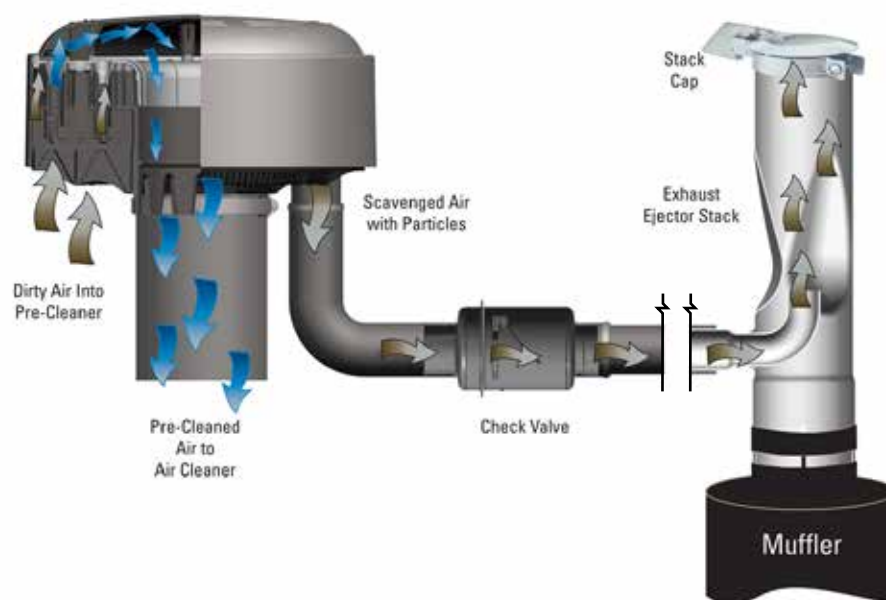

Exhaust Ejectors

- Can be used with any pre-cleaner that has scavenge tube connection.
- Adds only 4" (102 mm) to 8" (203 mm) H₂O (.3" to .6" Hg.) to exhaust backpressure
- Models all fit up to a muffler outlet tube outer diameter
- All models have a nominal OD outlet end for proper fit of stack caps and other accessories
- For proper structural support, muffler outlet tube length and stack engagement must be a minimum length of 1.5-2.0" / 38-51 mm
- Finish on all models is high temperature, black, semi-gloss finish



Interested in Scavenging a PowerCore® Air Cleaner?

See PowerCore Section for specific components and parts.

Exhaust Ejectors for Scavenged or Aspirated Air System

All exhaust ejectors are constructed of heavy-gauge, aluminized steel, and painted with a high-temperature black paint. Select the appropriate ejector by the intake airflow or exhaust flow (CFM) of your engine.

Engine Intake CFM		Exhaust CFM @ 900° F		Standard Ejectors			Expanded I.D. Ejectors			Length		Scavenge Tube O.D.	
Low	High	Low	High	Inlet Dia.* inches	mm	Part Number	Inlet Dia.* inches	mm	Part Number	inches	mm	inches	mm
220	365	554	919	3.02	77.0	H002612	3.16	80.3	H002762	12.00	304.8	1.25	32
315	450	793	1133	4.02	102.0	H002613	4.17	105.9	H002763	18.00	457.2	1.25	32
425	600	1070	1511	4.02	102.0	H002614	4.17	105.9	H002764	18.00	457.2	1.50	38
500	740	1259	1864	5.03	127.8	H002615	5.17	131.0	H002765	22.00	558.8	1.50	38
660	950	1662	2393	5.03	127.8	H002616	5.17	131.0	H002766	22.00	558.8	1.75	44
800	1150	2015	2896	6.04	153.4	H002617	6.19	157.0	H002767	24.00	609.6	2.00	51
950	1350	2393	3400	6.04	153.4	H002618	6.19	157.0	H002768	24.00	609.6	2.00	51
1100	1500	2770	3778	6.04	153.4	H002619	6.19	157.0	H002769	24.00	609.6	2.00	51

* This dimension only applies to 2.5" / 64mm of length – not the full length of the ejector.

3 ft. / .91 m Silicone Scavenge Hose & Lined Hose Clamp for:

- 1.25" / 32 mm Scavenge Tube: Hose: P171376 and Lined Hose Clamp P532924
- 1.50" / 38 mm Scavenge Tube: Hose: P171378 and Lined Hose Clamp P115200
- 2.00" / 51 mm Scavenge Tube: Hose: P171381 and Lined Hose Clamp P115200

Ejector Check Valve Prevents Exhaust Backflow

The exhaust ejector check valve prevents backflow of damaging exhaust gases by way of an internal hinge flap. Add an ejector check valve when configuring the intake system to expel filtered contaminant through the exhaust system.

- Mounts horizontally (see installation diagrams)
- Durable, non-corrosive metal construction
- No servicing required



H001023

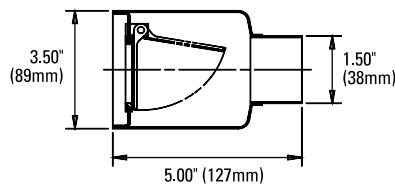

H000722

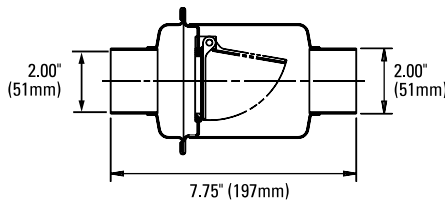

Check Valve Installation

The illustrations are side views of two-stage air cleaners, showing the position of the check valve. A 3" (76mm) inner diameter rubber reducing elbow or hump reducer is required for installation. See pages 206 – 208 for options.

Installation on F Series Cyclopac™

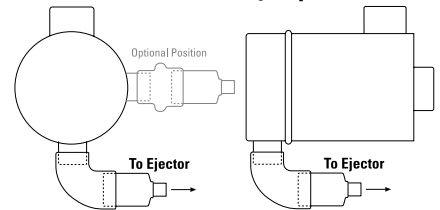

Installation on S Series Donacore™

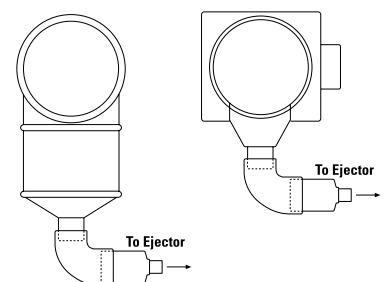

3-in-1 Intake Accessory Protects Against Moisture

- Primarily over-highway trucks
- For engine airflow of 700 to 1000+ cfm
- Improves intake system airflow and fuel economy by reducing restriction. Examples:
 - at 33 mph, 53 kmh = 3.5" H₂O restriction
 - at 45 – 52mph, 72 – 74 kmh = 4" H₂O restriction
 - at 60 mph, 97 kmh = 5" H₂O restriction
- Lightweight, non-corrosive, and durable — no service needed
- Inlet screen prevents large debris from entering intake ducting
- Side louvers ensure continuous airflow to intake system
- Common inlet sizes fit most installations
- Eliminates water from air intake system
 - at 700 cfm airflow = 90%
 - at 800 cfm airflow = 93%
 - at 1000 cfm airflow = 93%*

* based on item H001660



H001654
High profile model mounts on inlet stack, above and behind cab.



H001200
Low profile model designed for air cleaners mounted on the side of the cab.

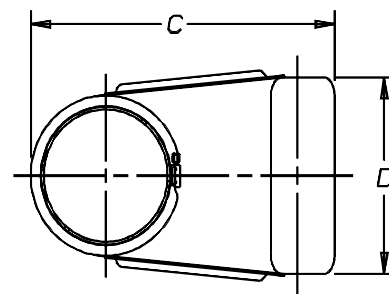
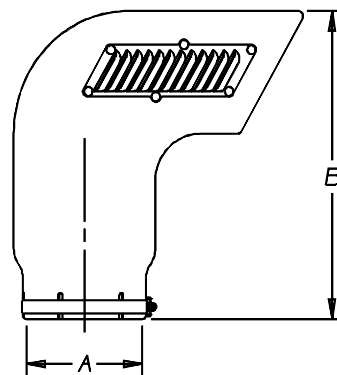

Air Ram Inlet Hood

Part Number	Inlet Diameter (A)		Height (B)		Depth (C)		Width (D)	
	in	mm	in	mm	in	mm	in	mm
MODELS WITH LOUVERS ON SIDE								
H001660	6.06	154	14.80	376	14.85	377	8.98	228
H001654	7.06	179	15.53	394	15.63	397	9.86	250
H001661	8.06	205	16.16	410	16.95	431	10.92	277
MODELS WITHOUT LOUVERS (LOW PROFILE)								
H001200	7.06	179	6.25	159	12.03	306	13.20	335

Note: One mounting band is included with each Air Ram

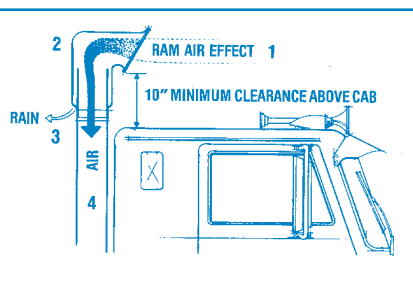

How Air Ram™ Works

- 1-Moisture-filled air enters Air Ram.
- 2-Air is naturally forced against rear wall. Moisture sticks to the wall, separating from the air.
- 3-Moisture collects on the Air Ram wall and drains down to and out of the drain hole.
- 4-Virtually moisture-free air passes into air cleaner.

Installation Note

All Air Ram inlet hoods MUST be installed with the screen facing forward to ensure best performance. Airflow restriction will not be reduced if the Air Ram faces sideways; but if it faces backwards, restriction does increase and adversely affects engine performance.

Horizontal, In-Line Moisture Skimmer Removes Water

Applications

- Allows 600 to 1200 cfm airflow
- Horizontal mount in engine air intake ducting

Features

- Removes over 80% of water before it can reach and damage the filter
- No service needed
- Made of durable rubber
- Collected water is automatically released by Vacuator™ Valve
- Adds little or no restriction to airflow
- Common inlet sizes fit most installations



Mounting Position

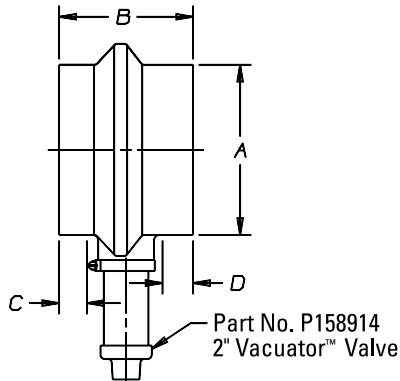
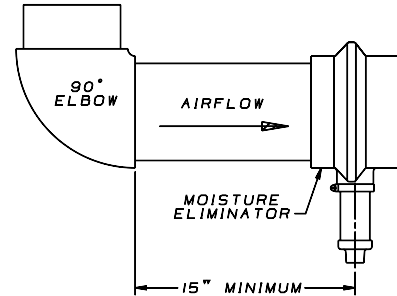

Moisture Skimmer

Part Number	CFM	Inlet Dia. (A)		Height (B)		Depth (C)		Width (D)	
		in	mm	in	mm	in	mm	in	mm
X005822	600-1000	6.00	152	6.00	152	1.25	32	1.37	35
X005900	800-1200	7.00	178	6.00	152	1.25	32	1.37	35
X005901*	800-1200	7.00	178	6.00	152	1.25	32	1.37	35

*Angled spout (see image on right)



Stack Extensions, Intake Tubing & Breathers

Air Stack Extensions

- For on-road and off-road trucks
- Helps extend filter life by elevating air inlet away from heavy dust concentrations and engine exhaust
- Installs easily and quickly with one clamp, which is included with unit
- Durable, corrosion-resistant steel construction

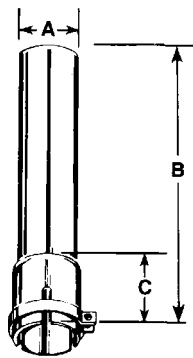

Air Stack Extension

-(A - O.D.)- in	mm	-----(B)---- in	mm	-----(C)---- in	mm	Part Number
3.75	95	29.00	737	1.50	38	X001744
4.50	114	30.25	768	1.50	38	X001746
5.00	127	29.00	737	1.50	38	X001747
6.00	152	31.50	800	1.50	38	H000484
7.00	178	28.62	727	1.50	38	H000483

Intake Tubing

- 16 gauge aluminum, unless footnoted
- 10 ft. (3m) length



Intake Tubing

-- O.D. -- in	mm	Part Number
3.00	76	P224684
4.00	102	P207367
5.00	127	P206849
5.50	140	P207368
6.00	152	P206850
7.00	178	P206851
8.00	203	P207369

Breathers

As sealed machinery operates, its internal air heats and expands; later, this air cools and contracts. To allow hot air out and cool air in **safely**, use a Donaldson breather filter. These handy, spin-on filters use sturdy oil-wetted filter media that resists damage from vibration.

- Designed for engines, air compressors, crankcases, transmissions, gearcases, air cylinders, air presses, hydraulic reservoirs
- Mount either vertically or horizontally
- Can be cleaned and reused

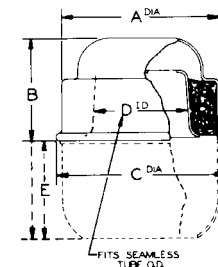
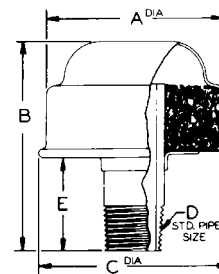

Part Number	--- A --- in	mm	--- B --- in	mm	--- C --- in	mm	--- D ---	--- E --- in	mm
STYLE A									
S000011	2.50	64	2.00	51	2.68	68	1/4" NPT	1.00	25
S000072	2.50	64	2.97	75	2.68	68	1/2" NPT	1.12	28
S000080	2.50	64	2.32	59	2.68	68	3/4" NPT	0.68	17
S000183	3.06	78	3.50	89	3.50	89	1" NPT	1.18	30
S000099	4.06	103	4.50	114	5.12	130	2" NPT	1.68	43
STYLE B									
S000067	2.50	64	1.62	41	2.75	70		1.50	n/a